



User Manual

FlexHome-(5-40) kWh-L

FlexHome-(5-40) kWh-L-AU



Due to the product development, the product specifications and functions are subject to change. The latest manual can be acquired via <https://www.solisstorage.com>.

Every attempt has been made to make this document complete, accurate and up-to-date.

Individuals reviewing this document and installers or service personnel are cautioned, however, that Solis reserves the right to make changes without notice and shall not be responsible for any damages, including indirect, incidental or consequential damages caused by reliance on the material presented including, but not limited to, omissions, typographical errors, arithmetical errors or listing errors in the material provided in this document.

Solis accepts no liability for customers' failure to comply with the instructions for correct installation and will not be held responsible for upstream or downstream systems Solis equipment has supplied.

The customer is fully liable for any modifications made to the system; therefore, any hardware or software modification, manipulation, or alteration not expressly approved by the manufacturer shall result in the immediate cancellation of the warranty.

Given the countless possible system configurations and installation environments, it is essential to verify adherence to the following:

- There is sufficient space suitable for housing the equipment.
- Airborne noise produced depending on the environment.
- Potential flammability hazards.
- Solis will not be held liable for defects or malfunctions arising from:
 - Improper use of the equipment.
 - Deterioration resulting from transportation or particular environmental conditions.
 - Performing maintenance incorrectly or not at all.
 - Tampering or unsafe repairs.
 - Use or installation by unqualified persons.
- This product contains lethal voltages and should be installed by qualified electrical or service personnel having experience with lethal voltages.

Catalog

1. Safety Precautions	- 1 -
1.1. Safety	- 3 -
1.2. Notice for Disposal	- 3 -
1.3. Personal Security	- 4 -
1.5. Environmental Requirements	- 9 -
1.6. Mechanical Safety	- 12 -
1.7. Battery Safety	- 14 -
2. Product Description	- 18 -
2.1. Product Overview	- 18 -
2.2. Product Appearance Introduction	- 19 -
2.3. Application Scenario	- 20 -
2.4. Product Specification	- 22 -
2.5. Heating logic	- 23 -
2.6. Fire suppression activation logic	- 23 -
2.7. Pressure relief activation logic	- 23 -
3. Transportation and Storage	- 24 -
3.1. Transportation Requirements	- 24 -
3.2. Storage Requirements	- 27 -
3.3. Battery Recharge	- 28 -
4. Energy Storage Installation	- 30 -
4.1. Unpacking and Packaging Contents Inspection	- 30 -
4.2. Tools Required for Installation	- 32 -
4.3. Installation Requirements	- 33 -
4.4. Energy Storage Installation	- 35 -
5. Electrical Connection	- 45 -
5.1. Install the power cable and protective grounding cable	- 46 -
5.2. Single-machine system parallel configuration guide:	- 49 -
5.3. Multi-system Parallel Configuration Guide	- 50 -
5.4. Standard Combiner Box	- 52 -
5.5. Recommendation Configuration	- 53 -
5.6. Inverter and datalogger FW requirements	- 54 -
6. System Configuration and Startup	- 55 -
6.1. Start-up Inspection	- 56 -
6.2. Single-system Startup Sequence	- 57 -
6.3. Multi-System Startup Sequence	- 58 -
6.4. Communication Protocol and Interface Description	- 59 -
6.5. Interface Definition	- 60 -
6.5. BMS Firmware Upgrade	- 64 -
6.6. SolisCloud Quick Commission Guide	- 65 -
7. System Maintenance	- 72 -
7.1. Energy Storage System Startup/Shutdown Procedure	- 73 -
7.2. Decommission of Battery Replacement	- 74 -
7.3. Regular Maintenance Items	- 75 -
7.4. List of Common Faults and Solutions	- 76 -
7.5. Main component replacement steps	- 78 -
7.6. Maintenance Requirements	- 79 -
7.7. Warranty Information and Requirement	- 80 -
8. Emergency Procedures	- 81 -
8.1. Emergency Treatment	- 81 -
8.2. On-site Response Plan for Electric Shock Accident	- 81 -
8.3. On-site Response Plan for Fire and Explosion Accidents	- 83 -

1. Safety Precautions

Statement

Before transporting, storing, installing, operating, using, or maintaining the equipment, please read this manual thoroughly and strictly adhere to its instructions, as well as all safety precautions indicated on the equipment and in the manual. In this manual, "equipment" refers to products, software, components, spare parts, or services related to this manual; "our company" refers to the manufacturer (producer), seller, or service provider of the equipment; and "you" refers to the individual responsible for transporting, storing, installing, operating, using, or maintaining the equipment.

The terms "Danger", "Warning", "Caution", and "Instructions" in the manual do not represent all safety precautions that must be observed. You are also required to comply with relevant international, national, or regional standards, as well as industry practices. Our company shall not be liable for any consequences resulting from violations of safety operation requirements or breaches of safety standards for equipment design, production, and use.

This equipment shall be used in an environment that complies with the design specifications. Otherwise, any resulting equipment failures, functional abnormalities, or component damage may not be covered under the equipment's warranty. Additionally, the company shall not be liable for any personal injuries, property losses, or other consequences arising from non-compliance.

All operations including transportation, storage, installation, operation, use, and maintenance shall comply with applicable laws, regulations, standards, and specifications.

Reverse engineering, decompilation, disassembly, modification, implantation, or other derivative operations on device software are strictly prohibited. No method shall be used to study the internal implementation logic of devices, obtain source code of device software, or infringe intellectual property rights. Additionally, disclosure of any performance test results for device software is not permitted.

The Company shall not be liable for any of the following circumstances or their resulting consequences:

- 1) Battery damage caused by earthquakes, floods, volcanic eruptions, debris flows, lightning strikes, fires, wars, armed conflicts, typhoons, hurricanes, tornadoes, extreme weather, or force majeure events;
- 2) Direct damage to batteries caused by on-site equipment operating conditions or external power parameters failing to meet normal operational requirements, including but not limited to excessively high or low actual battery operating temperatures, unstable grid conditions with frequent power outages;
- 3) Battery damage, drop, leakage, or rupture caused by improper operation or failure to connect the battery as required;
- 4) Battery damage caused by over-discharge due to delayed power supply installation and system connection at the site, attributable to your negligence;
- 5) Battery damage caused by your failure to complete acceptance inspection on time;

- 6) You did not configure the battery operation management parameters correctly;
- 7) Mixing batteries supplied by our company with other brands or models may accelerate capacity degradation, including but not limited to: using batteries from different manufacturers or with varying rated capacities.
- 8) Improper maintenance leading to frequent battery over-discharge, on-site capacity expansion, or prolonged inability to achieve full charging;
- 9) You failed to perform proper battery maintenance in accordance with the equipment operation manual, including but not limited to: neglecting to regularly check whether battery terminal screws were properly tightened;
- 10) Battery damage caused by improper storage (e.g., exposure to damp or rain-prone environments);
- 11) Failure to charge the battery promptly due to your negligence has resulted in prolonged storage, causing capacity loss or irreversible damage to the battery;
- 12) Battery damage caused by you or any third party, including but not limited to unauthorized relocation or installation of batteries in violation of our company's requirements;
- 13) You have not notified our company and have changed the battery usage scenario without authorization;
- 14) You are connecting additional loads to the battery yourself;
- 15) The battery has exceeded its maximum storage duration;
- 16) The battery has exceeded the warranty period. Batteries beyond the warranty period pose certain safety risks and should not be used further.
- 17) Any faults or damages caused by installation, repair, modification, or disassembly performed by non-Ginlong Technology Co., Ltd. after-sales service personnel shall be excluded if such actions are authorized by Ginlong Technology Co., Ltd. after-sales service department.
- 18) Malfunctions or damages caused by using components not supplied by Ginlong Technology Co., Ltd.;
- 19) Malfunctions or damages caused by accidental or human factors (operational errors, scratches, handling, impacts, improper voltage connection, etc.), including transportation-related damage;
- 20) Other malfunctions or damages not attributable to quality defects of Ginlong Technology Co., Ltd.'s equipment (including components).

1.1. Safety

The following types of safety instructions and general information appear in this document as described below:

**DANGER**

“ Danger ” indicates a hazardous situation which if not avoided , will result in death or serious injury.

**WARNING**

“ Warning ” indicates a hazardous situation which if not avoided , could result in death or serious injury.

**CAUTION**

“ Caution ” indicates a hazardous situation which if not avoided , could result in minor or moderate injury.

**NOTE**

“ Note ” provides tips that are valuable for the optimal operation of your product .

**WARNING: Risk of fire**

Despite careful construction , electrical devices can cause fires .

- . Do not install the inverter in an area containing flammable materials or gases .
- . Do not install the inverter in a potentially explosive atmosphere .

1.2. Notice for Disposal

This product shall not be disposed as household waste .

It must be segregated and brought to an appropriate disposal facility to ensure proper recycling.

This is to be done in order to avoid negative impacts on the environment and human health .

Local waste management rules shall be observed and respected.

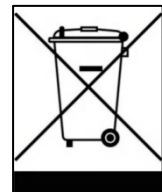

1.3. Personal Security

Danger:

- 1) Live-line operations are strictly prohibited during installation. Installation and removal of cables under live conditions are forbidden. The moment cable conductors come into contact with conductors, electric arcs, sparks, or fire explosions may occur, which can lead to fires or personal injuries.
- 2) When the equipment is energized, non-standard or incorrect operations may lead to fires, electric shocks, or explosions, resulting in casualties or property damage.
- 3) During the operation, it is strictly prohibited to wear conductive objects such as watches, bracelets, necklaces, rings, or other similar items to avoid electric shock burns.
- 4) Specialized insulating tools must be used during operation to prevent electric shock injuries or short-circuit faults. The insulation voltage rating must comply with local laws, regulations, standards, and specifications.
- 5) Special protective equipment must be used during the operation process, such as wearing protective clothing, insulating shoes, goggles, safety helmets, and insulating gloves.

Standard Requirements

- 1) Do not disable device protection devices or ignore warnings, alerts, and preventive measures on the manual and the device.
- 2) During equipment operation, if any malfunction that may cause personal injury or equipment damage is detected, the operation shall be immediately terminated, reported to the responsible person, and effective protective measures shall be implemented.
- 3) Do not power on the device if installation is incomplete or not confirmed by a professional.
- 4) Direct contact with power supply equipment is prohibited, as is contact through other conductors or indirect contact via damp objects. Before touching any conductor surface or terminal, the voltage at the contact point must be measured to confirm the absence of electric shock hazards.
- 5) During operation, the casing temperature is high and poses a risk of burns. Do not touch it.
- 6) In the event of a fire, immediately evacuate the building or equipment area and press the fire alarm bell, or call the fire emergency number. Under no circumstances should re-entry into the burning building or equipment area be permitted.

Personnel Requirements

- Personnel operating the equipment include professionals and trained personnel.
 1. Professionals: Individuals familiar with the principles and structure of equipment, possessing experience in equipment training or operation, and capable of identifying various potential hazards and risk levels during equipment installation, operation, and maintenance.
 2. Trained personnel: Individuals who have undergone appropriate technical and safety training and possess the necessary experience, capable of recognizing potential hazards associated with specific operations and taking measures to minimize risks to themselves or others.
- Personnel responsible for the installation and maintenance of equipment must undergo rigorous training to master correct operational methods, understand various safety precautions, and be familiar with relevant standards of the country/region where they are located.
- Only qualified professionals or trained personnel are permitted to install, operate, and maintain the equipment.
- Only qualified professionals are permitted to remove safety facilities and inspect equipment.
- Personnel engaged in special scenarios such as electrical operations, high-altitude work, and operation of specialized equipment must possess the special operation qualifications required by the local country/region.
- Replacement of equipment or components (including software) must be performed by authorized professionals.
- Only personnel authorized to operate the equipment may access it. Other individuals are prohibited from approaching the device.

1.4. Electrical Safety

Danger:

Before making electrical connections, ensure the equipment is undamaged to avoid electric shock or fire.

Nonstandard or incorrect operations may lead to accidents such as fires or electric shocks.

During operation, it is essential to prevent foreign objects from entering the equipment interior, as this may lead to short-circuit faults or equipment damage, load power supply degradation or power loss, and personal injury.

Warning:

For equipment requiring grounding, the protective earth wire must be installed first during installation and removed last during dismantling.

Standard Requirements

- 1) Installation, operation, and maintenance must strictly follow the step-by-step sequence outlined in the manual. Do not modify, add, or alter the equipment without authorization, nor change the installation sequence without permission.
- 2) Grid connection operation requires approval from the power regulatory authority of the respective country or region.
- 3) Comply with power station safety regulations, such as implementing the operation ticket and work ticket systems.
- 4) Temporary barriers or warning ropes shall be installed in the work area, and "No Entry" signs shall be displayed. Unauthorized personnel are strictly prohibited from entering.
- 5) Before installing or removing power cables, disconnect the equipment itself and its upstream and downstream switches.
- 6) If liquid enters the device, immediately turn off the power and do not continue using it.
- 7) Before operating the equipment, carefully inspect the tools used to ensure they meet the required specifications and record them in the logbook. After operation, retrieve the tools according to their quantity to prevent retention inside the equipment.
- 8) Before installing power cables, ensure the cable labels are correctly labeled and the cable terminals are properly insulated.
- 9) During equipment installation, a torque tool with appropriate range must be selected to tighten screws. When using a wrench for tightening, ensure the wrench is not tilted and that the torque value error does not exceed 10% of the specified value.
- 10) Fix the bolts using torque tools and conduct dual inspections with red and blue markings. After installation personnel confirm that the bolts are tightened, apply blue markings to the bolts; upon verification by inspectors, apply red markings (the line markings must extend beyond the bolt edges).
- 11) After installation, ensure all electrical components, including protective casings and insulating sleeves, are properly installed to prevent electric shock risks.
- 12) If the device has multiple inputs, disconnect all inputs and wait until the device is completely powered off before performing any operations.

- 13) When maintaining downstream power consumption or distribution equipment connected to the power supply system, the corresponding output switch of the power supply equipment must be disconnected.
- 14) During equipment maintenance, a "Do Not Close" signboard shall be hung on the upstream/downstream switches or circuit breakers, and warning signs shall be posted to prevent accidental connections. Power supply may only be restored after all faults have been resolved.
- 15) When performing fault diagnosis and troubleshooting, the following safety measures must be completed if power shutdown is required: Power shutdown> Voltage test> Installation of grounding wire> Hanging warning signs and setting up barriers.
- 16) Do not open the device's host panel.
- 17) Please regularly inspect the terminal screws of the device connection to ensure they are tightened and free from looseness.
- 18) If the cable is damaged, it must be replaced by a professional to avoid risks.
- 19) It is strictly prohibited to manually alter, damage, or obscure markings and nameplates on equipment. Signs that become illegible due to prolonged use should be promptly replaced.
- 20) Do not use water, alcohol, or oil-based solvents to clean electrical components inside and outside the equipment.
- 21) No operator access to energy hazardous area. Considered with special maintenance in instruction for battery, electrical energy hazard is not necessary for consideration. Removing the cover is prohibited and only support returning to the factory for repairing.
- 22) When installing an external emergency stop switch, the emergency stop can be controlled to open and close through communication control signals.

Grounding Requirements

- 1) The equipment grounding impedance shall comply with local electrical standards.
- 2) The equipment shall be permanently connected to a protective ground. Before operating the equipment, inspect the electrical connections to ensure reliable grounding.
- 3) Do not operate equipment without installed grounding conductors.
- 4) Do not damage the grounding conductor.
- 5) For devices using three-core sockets, ensure that the grounding terminal in the socket is connected to the protective earth.
- 6) For equipment with high contact current, the protective grounding terminal of the device housing must be grounded prior to connecting to the input power supply to prevent electric shock caused by the device's contact current.

Cabling Requirements

- 1) The selection, installation, and routing of cables must comply with local laws, regulations, and standards.
- 2) During the installation of power cables, circular wrapping or twisting is strictly prohibited. If insufficient cable length is detected, the power cable must be replaced. It is strictly forbidden to make joints or solder points within the power cable.
- 3) All cables must be securely connected, properly insulated, and of appropriate specifications.

- 4) Cable trays and conduit holes must be free of sharp edges. Protective measures must be implemented at cable routing points to prevent damage from sharp edges or burrs.
- 5) Cables of the same type should be bundled together, maintaining a straight and neat appearance without external skin damage; cables of different types must be laid separately, and mutual entanglement or cross-laying is strictly prohibited.
- 6) Upon completion of wiring or during the wiring process, immediately seal the cable opening with sealing compound to prevent moisture and small animals from entering.
- 7) Buried cables must be securely fastened using cable supports and cable clamps. The cables in backfilled soil areas should maintain tight contact with the ground to prevent deformation or damage caused by mechanical stress during soil backfilling.
- 8) When external conditions (e.g., installation methods or ambient temperature) change, cable selection validation must be conducted in accordance with IEC-60364-5-52 or local regulations and standards, including verifying whether the current-carrying capacity meets requirements.
- 9) Cables used in high-temperature environments may experience insulation layer aging or damage. The distance between cables and peripheral areas of heat-generating components or heat sources must be at least 30mm.
- 10) At excessively low temperatures, severe impacts and vibrations may cause brittle cracking of the cable's plastic outer sheath. To ensure construction safety, the following requirements must be adhered to:
- 11) All cables shall be installed at temperatures above 0°C. During cable handling, especially in low-temperature environments, gentle handling is required.
- 12) If the storage environment temperature of the cables is below 0°C, the cables must be moved to a room temperature environment and stored for at least 24 hours prior to deployment.
- 13) Prohibit improper operations such as pushing cables off vehicles to prevent cable damage that may lead to performance degradation, affecting current carrying capacity and temperature rise.

Antistatic Requirements

- 1) Static electricity generated by the human body can damage electrostatic-sensitive components on circuit boards, such as large-scale integrated circuits (LSI).
- 2) Prior to handling equipment such as handheld single boards, modules with exposed circuit boards, or application-specific integrated circuit (ASIC) chips, comply with electrostatic protection protocols. Wear anti-static workwear, anti-static gloves, or wrist straps, with the other end of the anti-static wrist strap properly grounded.
- 3) When handling a single board or a module with exposed circuit boards, always hold the edge of the board or module that does not contain components, and never touch the components with your hands.
- 4) Demounted panels or modules must be packaged with anti-static materials before storage or transportation.

1.5. Environmental Requirements

Danger:

It is strictly prohibited to place equipment in environments with flammable or explosive gases or smoke, and any operations must be avoided in such conditions.

The storage of flammable and explosive materials in equipment areas is strictly prohibited.

It is strictly prohibited to place equipment near heat sources or ignition sources, such as open flames, candles, heaters, or other heating devices, as exposure to heat may cause equipment damage or trigger fires.

Warning:

The equipment shall be installed in an area away from liquids. It is strictly prohibited to install it below water pipes, air outlets, or other locations prone to condensation water formation. Installation below air conditioning outlets, ventilation openings, or cable exit windows in machine rooms—areas susceptible to water leakage—is also forbidden to prevent liquid ingress into the equipment, which may cause malfunctions or short circuits.

Do not block ventilation ports, cooling systems, or cover them with other objects while the equipment is in operation to prevent high temperatures from damaging the device or causing fires.

Standard Requirements

- 1) The installation and usage environment must comply with local laws and regulations as well as relevant international and national standards pertaining to lithium battery products. Users of this equipment are obligated to protect it from fire or other damages.
- 2) Installation location must be inaccessible to children and kept away from daily work and living areas, including but not limited to the following spaces: studio, bedroom, lounge, living room, music room, kitchen, study, playroom, home theater, sunroom, bathroom, shower room, laundry room, and attic.
- 3) Installation is prohibited in enclosed, poorly ventilated areas, or locations exposed to direct cold air without adequate fire protection facilities or where firefighters cannot easily access. Do not place flammable or explosive materials around the equipment. Wall-mounted installation is recommended to avoid water accumulation.
- 4) Select an installation location with shade and avoid direct sunlight exposure. Alternatively, install a sunshade to prevent direct sunlight or rain exposure.
- 5) In areas prone to natural disasters such as floods, debris flows, earthquakes, and typhoons, corresponding preventive measures must be implemented during installation.
- 6) During operation, the chassis and heat sink temperatures may rise significantly. Avoid installing the device in easily accessible locations.
- 7) It is strictly prohibited to install the equipment in mobile environments such as ships, trains, and automobiles.
- 8) The temperature and humidity environment for device storage should be appropriate, with the devices kept in a clean, dry, and well-ventilated area, and protected from dust and condensation.

- 9) It is strictly prohibited to install or operate equipment beyond the scope specified in technical specifications, as this may adversely affect equipment performance and safety.
- 10) It is strictly prohibited to install, use, or operate outdoor equipment and cables under adverse weather conditions such as lightning, rain, snow, or winds exceeding level 6 (including but not limited to handling equipment, operating equipment and cables, plugging and unplugging signal interfaces connected outdoors, high-altitude work, outdoor installation, and door opening).
- 11) It is strictly prohibited to install the equipment in environments with direct sunlight, dust, smoke, volatile gases, corrosive gases, infrared radiation, organic solvents, or excessively high salt concentrations.
- 12) It is strictly prohibited to install equipment in environments containing metallic conductive dust or magnetic conductive dust.
- 13) It is strictly prohibited to install equipment in areas prone to the proliferation of microorganisms such as fungi and mold.
- 14) It is strictly prohibited to install equipment in areas with strong vibration, noise sources, or electromagnetic interference.
- 15) The installation site must have a solid and level ground surface, free from unfavorable geological conditions such as clayey soil, weak soil, or areas prone to subsidence. It is strictly prohibited to select low-lying areas susceptible to water accumulation or snow accumulation. The horizontal plane of the station should be elevated above the historical highest water level of the region.
- 16) It is strictly prohibited to install equipment in locations prone to water inundation.
- 17) If the equipment is installed in areas with dense vegetation, in addition to routine weeding, the ground beneath the equipment requires hardening treatment, such as laying cement or gravel.
- 18) Installation of equipment in salt-affected areas may lead to corrosion; therefore, outdoor installation in such regions is prohibited. Salt-affected areas refer to regions within 500 meters of the coastline or those exposed to sea winds. The extent of sea wind influence varies depending on meteorological conditions (e.g., typhoons, monsoons) or topographical features (such as embankments or hills).
- 19) During installation, operation, and maintenance, it is essential to first remove standing water, ice, snow, or other debris from the top surface.
- 20) When installing the equipment, ensure the mounting surface is sturdy and meets the load-bearing requirements. If wall-mounted installation is selected, verify that the wall can support three times the product weight.
- 21) After equipment installation, empty packaging materials such as cardboard boxes, foam, plastics, and tie straps should be removed from the equipment area.
- 22) Storage devices must be stored according to the storage requirements section. Damage caused by non-compliance with storage conditions is not covered by the warranty.
- 23) The altitude does not exceed approximately 4000 meters.
- 24) Not to be placed in environments with precipitation or high humidity (>95%).

Note:

- 1) The operation and service life of energy storage systems are temperature-dependent. Install them at ambient temperature or slightly above ambient temperature.
- 2) The operating temperature range for energy storage systems is -20 to 55°C. When installed in cold environments, the system activates its built-in thermal control system to heat the batteries for improved performance. This heating process consumes rechargeable power, resulting in a temporary reduction in system efficiency.
- 3) If stored in a cold environment (e.g., 0°C) prior to installation, the energy storage system requires heating before charging, with the heating duration specified in the table below. It is recommended to place the energy storage system in a warm location before installation to facilitate efficient commissioning.
- 4) When the ambient temperature of the energy storage system exceeds 45°C or falls below -10°C, the battery charge/discharge power will be derated.

1.6. Mechanical Safety

Danger:

When working at heights, safety helmets, safety belts or harnesses must be worn and secured to sturdy structural components. It is strictly prohibited to suspend from mobile or unstable objects or metal surfaces with sharp edges to prevent hook slippage and subsequent falls.

Warning:

All tools must be fully prepared and pass inspection by professional institutions. The use of tools with scratches, those failing inspection, or those exceeding the inspection validity period is prohibited. Ensure that tools are securely fastened and not overloaded.

Drilling holes in equipment is strictly prohibited. Such operations may compromise the equipment's sealing integrity, electromagnetic shielding performance, internal components, and cables. Metal debris generated during drilling can enter the equipment, potentially causing short circuits in circuit boards.

Standard Requirements

- 1) Paint scratches occurring during equipment transportation and installation must be promptly repaired, and prolonged exposure of scratched areas is strictly prohibited.
- 2) Arc welding, cutting, or similar operations on the equipment are strictly prohibited without prior assessment by our company.
- 3) No additional equipment shall be installed on the top of the device without prior assessment by our company.
- 4) When working in the space above the top of the equipment, additional protection should be installed on the top to prevent damage to the equipment.
- 5) Use the correct tool and master its proper usage.

High-altitude safety

- 1) Any work carried out at a height of more than 2 meters above the ground is considered high-altitude work, and a supervisor must be assigned for high-altitude work.
- 2) Only after completing relevant training and obtaining the corresponding qualification certificates can one commence high-altitude work.
- 3) High-altitude work should be suspended if the steel pipe is not dry from rainwater or other potentially hazardous conditions. After such conditions are resolved, the safety supervisor and relevant technical personnel must inspect all working equipment and confirm safety before commencing operations.
- 4) At high-altitude work sites, hazardous exclusion zones shall be demarcated with conspicuous signage, and unauthorized personnel are strictly prohibited from entering.
- 5) Guardrails and warning signs shall be installed at edges and openings during high-altitude operations to prevent falls and loss of footing.
- 6) It is strictly prohibited to pile scaffolding, planks, or other debris on the ground below the high-altitude work area. Personnel on the ground are forbidden to remain or pass directly beneath the high-altitude work area.

- 7) Carry operational instruments and tools properly to prevent tool falls that may cause equipment damage or personal injury.
- 8) It is strictly prohibited for high-altitude workers to throw objects from heights to the ground or to throw objects from the ground to heights. Objects should be transported using hoisting ropes, hoisting baskets, elevated vehicles, or cranes.
- 9) Simultaneous operations between upper and lower levels should be avoided whenever possible. If unavoidable, dedicated protective shelters must be installed between levels or alternative safety measures implemented, with strict prohibition of tool or material storage on upper levels.
- 10) When dismantling scaffolding after project completion, the process should be carried out in layers from top to bottom, and simultaneous removal of upper and lower layers is strictly prohibited. During the dismantling of any section, measures must be taken to prevent collapse of other sections.
- 11) High-altitude workers must strictly adhere to high-altitude safety regulations during operations. The company shall not be liable for any accidents resulting from violations of these safety regulations.
- 12) It is strictly prohibited to engage in laughing or playing around during high-altitude work, and resting in high-altitude work areas is strictly forbidden.

Ladder Safety

- 1) When electric-related high-altitude operations are involved, wooden ladders or insulated ladders should be used.
- 2) For elevated operations, prioritize the use of platform ladders with guardrails, and avoid straight ladders.
- 3) Before using a ladder, ensure it is in good condition and meets the required load capacity. Overloading is strictly prohibited.
- 4) Ladders must be placed in a stable location, and someone must hold the ladder during operation.
- 5) When climbing a ladder, maintain body stability and ensure that the center of gravity does not deviate from the edge of the ladder frame to minimize risks and ensure safety.
- 6) The rope must be securely fastened when using a stepladder.
- 7) When using a single-step ladder, an inclination of 75° is recommended. You can measure the angle with a protractor, as shown in the figure below.
- 8) If a single-step ladder is used, the wider rung should be positioned downward or protective measures should be implemented at the base of the ladder to prevent slipping.
- 9) When using a single-step ladder, the maximum height at which feet can be placed should not exceed the fourth step from the top of the ladder when counting downward.
- 10) If using a single-step ladder to climb onto the platform, the vertical height of the ladder extending beyond the platform must be at least 1 meter.

Drilling Safety

- 1) Prior to drilling, consent must be obtained from both the client and the contractor.
- 2) Safety protective equipment such as goggles and protective gloves should be worn during drilling.
- 3) During drilling, avoid pre-installed pipelines or electrical cables to prevent short circuits or other hazards.

1.7. Battery Safety

Danger:

It is strictly prohibited to short-circuit the positive and negative terminals of a battery, as this may cause a short circuit. A battery short circuit can instantly generate a high current and release a large amount of energy, leading to battery leakage, smoking, release of flammable gases, thermal runaway, fire, or explosion. To prevent battery short circuits, maintenance on batteries while energized is not permitted.

Do not expose batteries to high-temperature environments or surrounding heat-generating devices, such as intense sunlight, ignition sources, transformers, or heaters. Battery overheating may lead to liquid leakage, smoking, release of flammable gases, thermal runaway, fire, or explosion.

Batteries must not be subjected to mechanical vibration, drops, collisions, penetration by hard objects, or pressure impacts, as these may cause battery damage or fire.

Disassembly, modification, or damage to the battery (e.g., insertion of foreign objects, external compression, immersion in water or other liquids) is strictly prohibited to prevent battery leakage, smoking, release of flammable gases, thermal runaway, fire, or explosion.

Do not allow battery terminals to contact other metal objects, as this may cause heating or electrolyte leakage.

Using or replacing batteries of incorrect models may pose risks of fire or explosion. Please use batteries of the manufacturer-recommended specified models.

Battery electrolytes are toxic and highly volatile. In the event of electrolyte leakage or unusual odors, avoid contact with the leaked liquid or gas. Non-professionals must not approach the area and should immediately contact professional personnel for handling. Professionals must wear protective equipment including goggles, rubber gloves, gas masks, and protective suits. Immediately disconnect the equipment, remove the leaking battery, and contact technical engineers for further action.

A battery is a sealed system that typically releases no gases under normal operation. However, extreme abuse scenarios—including fire exposure, needle penetration, compression, lightning strikes, overcharging, or other conditions that may trigger thermal runaway—can cause battery damage or abnormal chemical reactions inside the cell. These incidents may lead to electrolyte leakage or the release of gases such as CO and H₂. It is essential to ensure proper flammable gas containment measures are in place at the scene to prevent combustion or equipment corrosion.

Gases produced by battery combustion can irritate the eyes, skin, and throat. Protective measures should be taken.

Warning:

The battery should be installed in a location away from liquids. It is strictly prohibited to install it below air conditioning outlets, ventilation openings, electrical room exit windows, water pipes, or other areas prone to leakage, to prevent liquid ingress into the equipment interior, which may cause malfunctions or short circuits.

Prior to battery disassembly and unpacking, ensure that the outer packaging box remains intact without damage during storage and transportation. Place the batteries correctly according to the markings on the packaging box. Strictly prohibit inverted, lateral, upright, or tilted placement. When stacking, comply with the stacking requirements specified on the outer packaging to avoid any impact or drop that may cause battery damage or disposal.

After removing the battery from its packaging, place it in the specified orientation. Strictly prohibit inverted, lateral, upright, tilted, or stacked positions to avoid damage or scrapping caused by impacts or drops.

According to the torque specified in the text for tightening the fastening screws of copper bars or cables, conduct regular inspections to verify whether the screws are properly tightened, free from rust, corrosion, or other foreign objects, and clean them thoroughly. Otherwise, loose connections may result in excessive voltage drop at the joints, and under high current conditions, excessive heating could lead to battery damage.

After battery discharge, it should be charged promptly to prevent damage caused by over-discharge.

Statement

The Company shall not be liable for battery damage, personal injury, property loss, or other consequences resulting from the following causes:

- 1) Force majeure factors such as earthquakes, floods, volcanic eruptions, debris flows, lightning strikes, fires, wars, armed conflicts, typhoons, hurricanes, tornadoes, and extreme weather events;
- 2) Failure to comply with the user manual guidelines or the company's direct recommendations, including but not limited to the following scenarios:
 - a. Due to the on-site equipment operating environment or external power parameters failing to meet the environmental requirements for normal operation, including but not limited to excessively high or low actual battery operating temperatures, unstable grid conditions with frequent power outages;
 - b. Battery drop, improper operation, or incorrect connection;
 - c. Over-discharge caused by delayed acceptance or power-on after battery installation completion;
 - d. Without prior permission from the company, mixing different types of batteries, including but not limited to: mixing with batteries of other brands or batteries with different rated capacities;
 - e. Frequent over-discharge caused by improper battery maintenance;
 - f. Altering battery usage scenarios without prior authorization from the company;
 - g. Failure to follow the user manual guidelines for battery maintenance, including but not limited to: neglecting to regularly check whether battery terminal screws are properly tightened;

- h. Failure to comply with the user manual guidelines for battery transportation, storage, or charging;
 - i. Failure to comply with the company's guidelines during battery relocation or reinstallation.
- 3) The battery has exceeded the warranty period. Batteries past the warranty period pose certain safety risks and should not be used.

Standard Requirements

Note:

To ensure battery safety and accurate management functions, please use batteries configured by our company. We will not be liable for any battery-related issues caused by using non-configured batteries.

- 1) Before installing, operating, or maintaining the battery, please read the manufacturer's manual and comply with the manufacturer's requirements. The safety precautions in this manual are provided for reference only. For more detailed safety instructions, please refer to the manufacturer's manual.
- 2) Use the battery within the specified temperature range. Charging is prohibited when the ambient temperature is below the lower operating temperature limit to avoid internal short circuits caused by low-temperature charging.
- 3) Before removing the battery from its packaging, inspect whether the packaging is intact. Batteries with damaged packaging must not be used. If damage is detected, immediately notify the transporter and manufacturer.
- 4) After removing the battery from its packaging, power must be applied within 24 hours. If power cannot be applied promptly, the battery must be reinserted into the packaging and stored in a dry, non-corrosive gas environment indoors. During subsequent maintenance, the power-off period must not exceed 24 hours.
- 5) Damaged batteries (due to drops, impacts, bulging, or shell dents) may cause liquid leakage or release flammable gases. Never use damaged batteries. If you notice leakage or structural deformation, immediately contact your installer or professional maintenance personnel for removal and replacement. Do not store damaged batteries near other equipment or flammable materials. Non-professionals should avoid approaching damaged batteries.
- 6) Before operating the battery, ensure there are no irritants or burnt odors around the battery.
- 7) During battery installation, it is strictly prohibited to place installation tools, metal parts, or debris on the battery. After installation completion, promptly clean the battery surface and surrounding areas.
- 8) If the battery is accidentally exposed to water, continue installation is prohibited. Transport it to a safe isolation site and dispose of it promptly.
- 9) Before installing the battery pack, inspect its casing for deformation or damage.
- 10) Check if the battery terminals are accidentally grounded. If so, disconnect the battery terminals from ground.
- 11) Do not perform welding, grinding, or similar operations around the battery to avoid generating electric sparks or arcs that may cause fires or other hazards.
- 12) When batteries are not in use for an extended period, they should be stored and

recharged according to battery specifications.

- 13) The use of equipment that does not comply with local laws, regulations, and standards for charging and discharging is prohibited.
- 14) During installation and maintenance, the battery circuit should remain disconnected.
- 15) Damaged batteries should be monitored during storage to determine the absence of signs such as smoke, flames, electrolyte leakage, or heating.
- 16) In case of battery failure, the surface temperature may become excessively high; contact should be avoided to prevent burns.
- 17) Do not stand or lean on, or sit on the device.
- 18) Do not use the battery for the following purposes during backup power scenarios.
 - a. Medical devices directly related to human life.
 - b. Used for control equipment such as trains and elevators, which may cause personal injury.
 - c. For computer systems with social and public significance.
 - d. For use near medical equipment.
 - e. Equipment similar to the aforementioned description.
- 19) No operator access to energy hazardous area. Considered with special maintenance instruction for battery, electrical energy hazard is not necessary for consideration. Removing the cover is prohibited and only support returning to the factory for repairing.

Short-circuit Protection

- 1) When installing or maintaining batteries, use insulating tape to cover exposed cable terminals.
- 2) Avoid foreign objects (such as conductive materials, screws, liquids, etc.) entering the battery interior to prevent short circuits.

Recovery Processing

- 1) Please dispose of used batteries in accordance with local laws and regulations. Do not treat batteries as household waste. Improper disposal of batteries may lead to environmental pollution or explosions.
- 2) If the battery leaks or becomes damaged, contact technical support or a battery recycling company for disposal.
- 3) When the battery exceeds its service life and becomes unusable, contact a battery recycling company for disposal.
- 4) Avoid exposing used batteries to high temperatures or direct sunlight.
- 5) Avoid exposing used batteries to high humidity or corrosive environments.
- 6) Faulty batteries must not be reused and should be promptly disposed of by contacting battery recycling companies to prevent environmental pollution.

2. Product Description

2.1. Product Overview

The FlexHome-(5-40)kWh-L is a residential energy storage system developed using lithium iron phosphate batteries. It provides reliable power support for various devices and systems, making it ideal for household energy storage, backup power supply, photovoltaic power generation integration, and applications requiring long cycle life.

The energy storage system comprises a low-voltage control module and a battery expansion module, capable of energy storage and release in accordance with the requirements of the inverter management system.

Product Features and Advantages:

- 1) Modular stacking design: Supports flexible parallel connection of 1-8 16S PACK units, enabling intelligent parallel operation for single or multiple clusters.
- 2) Multi-layer security protection: Features multi-stage overvoltage, overcurrent, and overheating protection, with two-tier active protection including split-excitation tripping.
- 3) Smart BMS management: Supports charge-discharge balancing, state of charge (SOC) estimation, and online upgrades.
- 4) All-weather adaptation: Integrated intelligent heating system ensures stable operation in low-temperature environments.

Definition of the Model

Low-Voltage Control Module Model of FlexHome-(5-40)kWh-L Energy Storage System is FlexHome-CB210A-L

Characteristic	Meaning	Introduction
FlexHome	Product Series	FlexHome: Modular Stackable Home Energy Storage System
CB210A	Low-Voltage Control Module	CB210A: The current of low-voltage control module is 210A
L	System Voltage	L: low voltage

The battery expansion module model of FlexHome's (5-40)kWh-L energy storage system is FlexHome-BAT5kWh-L.

Characteristic	Meaning	Introduction
FlexHome	Product Series	FlexHome: Modular Stackable Home Energy Storage System
BAT5kWh	Battery Capacity	BAT5kWh: 5kWh battery module
L	System Voltage	L: low voltage

2.2. Product Appearance Introduction

Figure 2-3 Battery Appearance

No.	Description
1	Power module
2	LED indicator light
3	Battery module
4	Install the base
5	DC Switch
6	Power button

2.3. Application Scenario

System Operation Instructions

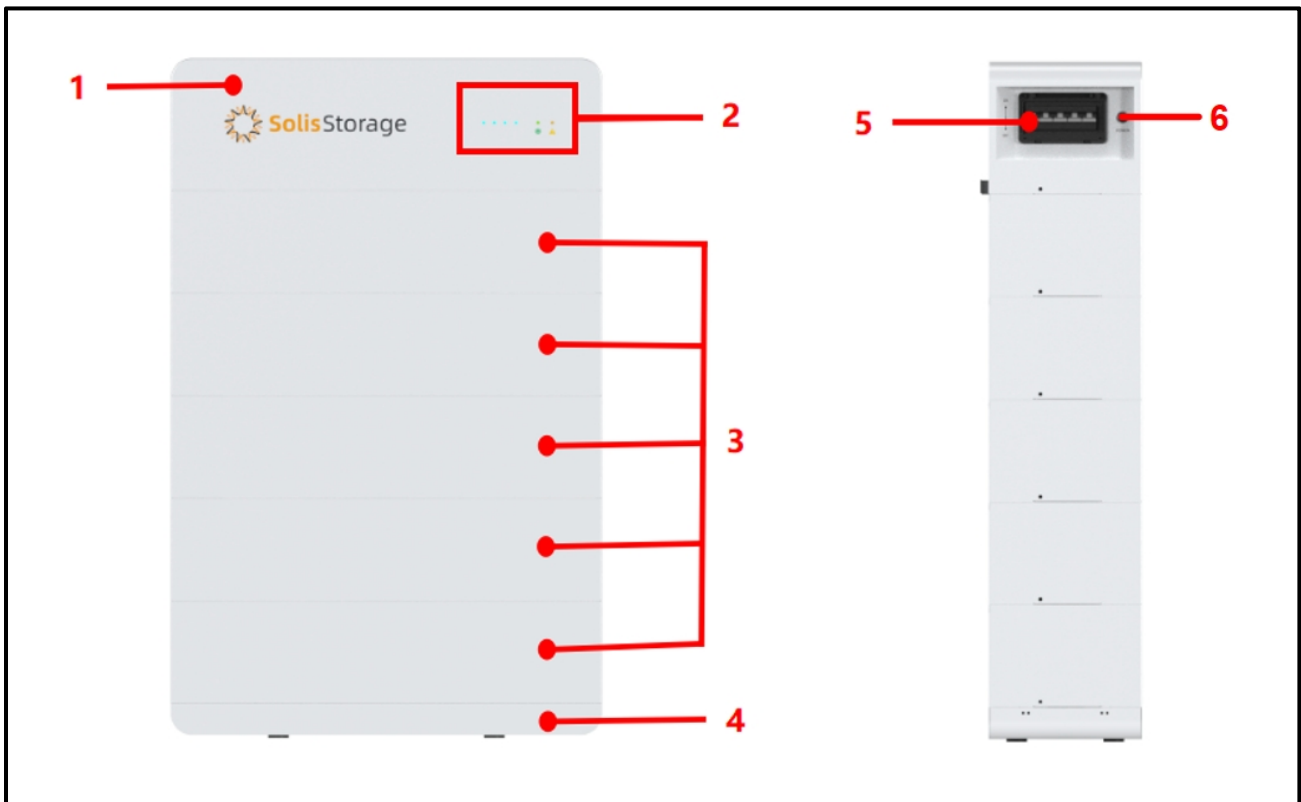
The system consists of PV module, battery, hybrid inverter, CT or smart meter.

The PV Module converts solar energy into electric energy, which is then converted by the inverter to charge the battery or power loads or feed into the grid.

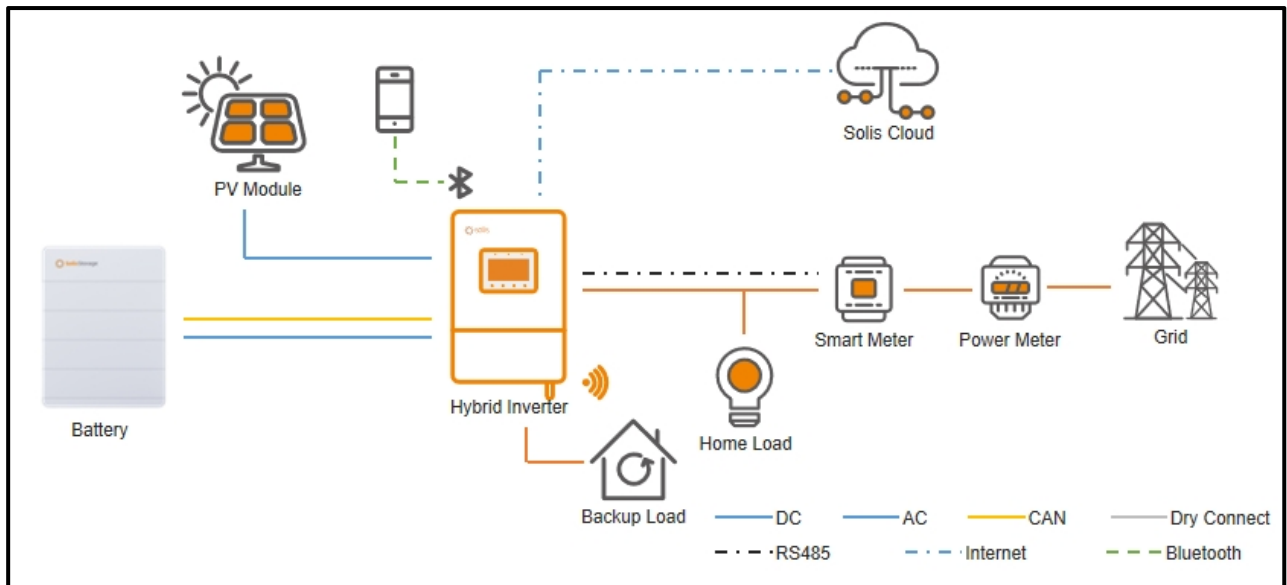

Figure 2-4 System Diagram

Battery Parallel Operation Instructions

The energy storage system supports parallel expansion, accommodating up to 4 clusters of energy storage systems simultaneously.

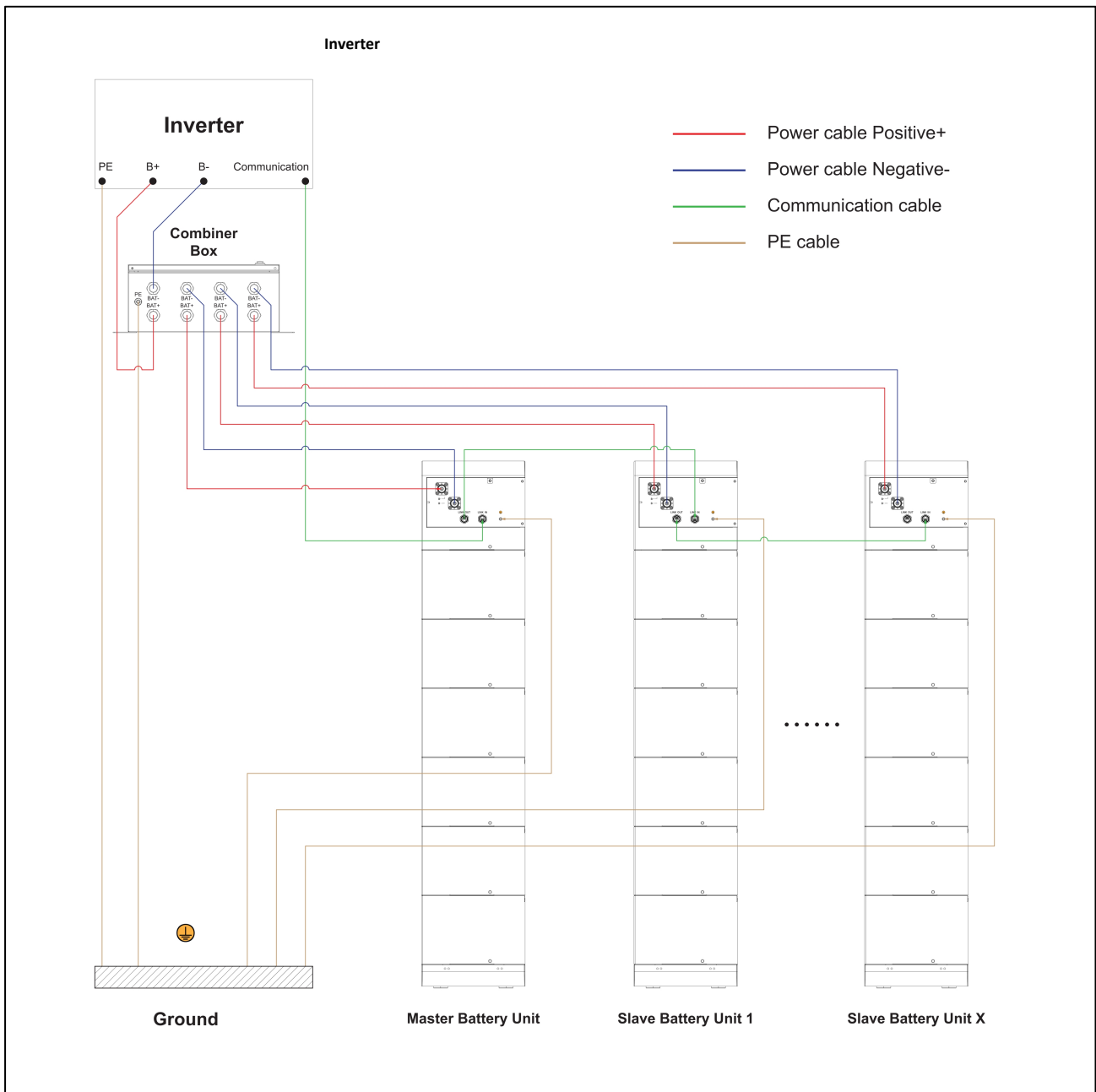

Figure 2-5 Energy Storage Parallel Guidance

2.4. Product Specification

System Performance Parameters Table:

Order number	Project	System parameter						
1	Model	FlexHome- (5-40) kWh-L						
2	Battery type	LiFePO4						
3	Operating voltage range	44.8-57.6V($\geq 0^{\circ}\text{C}$) 36.8-57.6V($\leq 0^{\circ}\text{C}$)						
4	Maximum charging voltage	57.6V						
5	Maximum discharge voltage	44.8V($\geq 0^{\circ}\text{C}$)/36.8V($\leq 0^{\circ}\text{C}$)						
6	Number of battery modules	2	3	4	5	6	7	8
7	Rated voltage	51.2V						
8	Rated energy /kWh	10	15	20	25	30	35	40
9	Maximum continuous charging current/A	100	150	200	210	210	210	210
10	Maximum continuous discharge current/A	200	210	210	210	210	210	210
11	Scalability	A single battery cluster supports up to 8 stacked parallel devices and can handle 4 clusters simultaneously.						
12	System energy capacity	5-160KWh						
13	Maximum charge and discharge current	210A						
14	Maximum peak current	315A, 10S						
15	Maximum charge-discharge power	10KW						
16	Discharge Depth (DOD)	100%						
17	Communication mode	CAN/RS485						
18	Match inverter brand	Solis						
19	Dimensions (W × H × D, mm)	800X28 5X690	800X28 5X880	800X2 85X10 70	800X2 85X12 60	800X28 5X1450	800X2 85X16 40	800X2 85X18 30
20	Operating temperature range	Charging: -20 to 55°C (including heating film), Discharging: -20 to 55°C						
21	Storage temperature range	Ambient temperature: -10°C to 45°C Recommended storage temperature: 10°C to 30°C						
22	Relative humidity range	5-95% RH (long-term 65% ± 20% RH)						
23	Maximum working altitude	4000m (load reduction applied at $\geq 2000\text{m}$ altitude)						
24	Cooling-down method	natural cooling						
25	Levels of protection	IP66						
26	Noise	$\leq 30\text{db}$						
27	Shell type	metal plate						
28	Way to install	Wall-mounted & floor-to-wall installation (default)						
29	Certification	IEC 62619、IEC 63056、ISO13849、VDE 2510-50、UN 38.3、EN/IEC61000-6-1/2/3/4、IEC 60730-1、IEC 60529 (IP)、INMETRO 140						

2.5. Heating logic

- 1) $T_{min} \leq 0^{\circ}\text{C}$, the low-temperature protection alarm, after a delay of 5 seconds, it enters the pure heating mode, disconnects the main relay, closes the heating film relay, and requests a charging current of 5A(from inverter).
- 2) $T_{min} \geq 5^{\circ}\text{C}$, the low-temperature protection alarm will gone, after a delay of 5 seconds, the pure heating mode is switched to the charging and heating mode. The main relay is closed. In addition to the normal requested current, an additional heating film charging current is requested. And if there is a discharge request at this time, it will disconnect the heating film relay.
- 3) T_{min} is $\geq 10^{\circ}\text{C}$, after a delay of 5 seconds, it is switched to the charging mode, disconnect the heating film relay.

Heating time information at different temperatures					
Heating start temperature	-20°C	-15°C	-10°C	-5°C	0°C
Heating stop temperature	10°C	10°C	10°C	10°C	10°C
Estimated heating time	3H	2.5H	2H	1.5H	1H

Note:

Only when the battery cell temperature T_{min} is $\leq 0^{\circ}\text{C}$, and in charging mode, the battery cell will be heated. When the battery cell temperature T_{min} is $> 0^{\circ}\text{C}$, the heating function will not be activated.

2.6. Fire suppression activation logic

The temperature inside the PACK rises to around $185^{\circ}\text{C} (\pm 10^{\circ}\text{C})$, it will activate the spray, $\leq 5\text{s}$

2.7. Pressure relief activation logic

When Internal and external pressure difference is more than $6 \pm 1.5\text{kPa}$, it will open the valve.

3. Transportation and Storage

3.1. Transportation Requirements

- 1) When handling heavy objects, adequate load-bearing preparation should be performed to avoid injury or sprain caused by the weight.

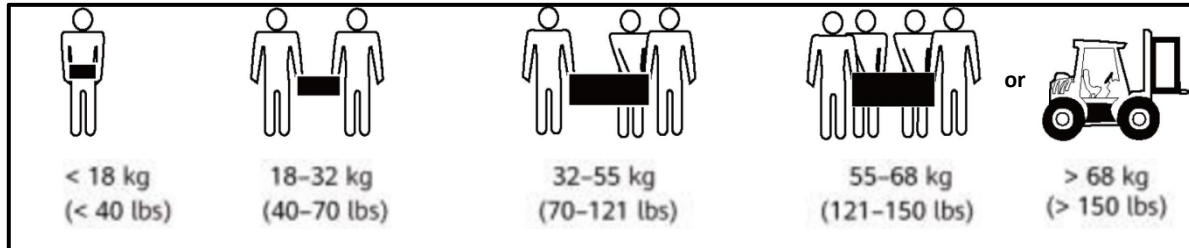

- 2) When multiple individuals are engaged in heavy lifting operations simultaneously, factors such as height must be considered to ensure rational personnel allocation and division of labor, thereby achieving balanced weight distribution.
- 3) When two or more individuals are engaged in lifting heavy objects together, one person should be responsible for directing the operation, ensuring synchronized lifting or lowering of equipment while maintaining uniform steps.
- 4) When handling equipment manually, protective gloves and safety footwear such as work shoes should be worn to prevent injuries.
- 5) When manually lifting equipment, first approach the object, crouch down, and use the strength of straightened legs (avoid using spinal force) to slowly and steadily lift the object. Sudden forceful lifting or twisting of the trunk is strictly prohibited.
- 6) Do not lift heavy objects quickly to a height above waist level. First, place the object on a workbench at waist height or an appropriate location, adjust the position of your palms, and then proceed with lifting.
- 7) When handling heavy loads, force must be applied evenly and steadily; movement speed should be uniform and low; positioning requires smooth and slow motions to avoid any impacts or drops that may scratch the equipment surface or damage its components and cables.
- 8) When handling heavy objects, special caution should be exercised at workbenches, slopes, staircases, and other areas prone to slips. When transporting heavy loads across thresholds, ensure that the door width is sufficient for equipment passage to prevent finger injuries or abrasions.
- 9) When lifting heavy objects, move the feet instead of twisting the waist. When it is necessary to lift and transfer heavy objects simultaneously, first direct the feet toward the intended direction of movement before proceeding with the lifting.
- 10) When handling equipment with a forklift, the forks must be positioned in the center to prevent tipping over. Before moving, secure the equipment to the forklift using ropes; during transportation, a dedicated supervisor must be present.
- 11) Transportation should be conducted via sea freight or well-maintained highways, with rail and air transport being unsupported. During transportation, efforts should be made to minimize jolting and tilting.

Danger:

Rudely handling is prohibited, as it may lead to battery short circuits, damage (e.g., leakage, rupture), fire, or explosion.

Warning:

During handling, avoid transporting the battery through its terminals, bolts, or cables to prevent damage.

During handling, the battery must be transported in the direction specified by the manufacturer. Inversion, tilting, dropping, mechanical impact, exposure to rain or snow, and immersion in water are strictly prohibited.

Prior to battery disassembly and unpacking, ensure that the outer packaging box remains intact without damage during storage and transportation. Place the batteries correctly according to the markings on the packaging box. Strictly prohibit inverted, lateral, upright, or tilted placement. When stacking, comply with the stacking requirements specified on the outer packaging to avoid any impact or drop that may cause battery damage or disposal.

- 1) According to the hazardous goods classification criteria outlined in the United Nations Recommendations on the Transport of Dangerous Goods Model Regulations (TDG or Orange Book), batteries are classified as Category 9 hazardous materials and have passed the relevant tests specified in Section III, Chapter 38.3 of the UN Manual of Tests and Standards for Recommendations on the Transport of Dangerous Goods.
- 2) Comply with the latest international and domestic regulations governing the transportation and storage of hazardous materials, including but not limited to the International Maritime Dangerous Goods Code (IMDG Code), the Agreement Concerning the International Carriage of Dangerous Goods by Road (ADR), and the People's Republic of China Transportation Industry Standard for Road Transport of Dangerous Goods (JT/T617). Additionally, meet the regulatory requirements of transportation authorities in the country of origin, transit countries, and destination countries. Prior to transportation and storage, conduct proper packaging, labeling, and marking in accordance with local laws and standards of the country of operation, and complete relevant product and packaging tests in advance.
- 3) Transportation and warehousing service providers must possess the relevant hazardous materials operation qualifications required by local regulations and standards at the location where business operations take place. Transport must utilize rigid box trucks, and the use of open-top trucks is strictly prohibited.
- 4) Transportation should be conducted via sea freight or well-maintained highways, with rail and air transport being unsupported. During transportation, efforts should be made to minimize jolting and tilting.
- 5) Prior to transportation, compliance and accurate declaration must be performed. The battery packaging and labeling must be inspected to ensure they are intact without odors, leakage, smoking, or fire hazards. Transportation is prohibited if any of these conditions are observed.
- 6) Transportation packaging boxes must be securely fastened. During loading, unloading, and transportation, care must be taken to handle them gently, avoiding side placement or inversion. Moisture-proof measures should be implemented, and packages must be firmly tied to prevent displacement. Labels for hazardous materials must face outward.

- 7) When handling batteries, handle them gently and avoid any impact. Personal safety must be prioritized.
- 8) Unless otherwise specified, dangerous goods shall not be mixed with goods containing food, pharmaceuticals, animal feed and their additives in the same vehicle or container; sharp objects shall not be loaded in the same vehicle.
- 9) If the laws and regulations of the country where the business is located permit the intermodal transportation of specific categories of hazardous goods or the combined transportation of hazardous goods and general cargo, isolation must be implemented in accordance with local regulations and standards. In the absence of explicit requirements from the country of business location, when hazardous cargo packages are loaded together with general cargo in the same vehicle or container, isolation may be conducted as follows:
 - a. Use isolation materials of the same height as the packaging.
 - b. Maintain a minimum spacing of 0.8 m around all areas.
- 10) Batteries must be stored in designated compartments, kept away from heat sources, protected from moisture and exposure to water or rain, and stacked according to the markings on the outer side of the packaging box. Overstacking is prohibited, as is side placement or inversion.
- 11) Prior to transportation of faulty batteries (characterized by carbonization, leakage, swelling, water ingress, etc.), insulation treatment must be applied to both positive and negative terminals. After packaging, the batteries should be promptly placed in an explosion-proof insulated container, with external documentation including station name, address, time, and observed symptoms recorded on the outer box.
- 12) During transportation of faulty batteries from the site, avoid storage areas for flammable materials, residential areas, or other locations prone to crowd gatherings, such as public transportation vehicles or elevators.

3.2. Storage Requirements

Warning:

- 1) The battery is stored indoors, protected from direct sunlight or rain, with good ventilation and dryness. The surrounding environment is clean, free from excessive infrared radiation or other radioactive emissions, organic solvents or corrosive gases, and metallic conductive dust. It is kept away from heat sources and ignition sources.
- 2) In case of battery failure (carbonization, leakage, swelling, water ingress, etc.), the batteries must be promptly transferred to a hazardous materials warehouse for separate storage, maintaining a minimum distance of 3 meters from surrounding flammable materials, and disposed of as soon as possible.
- 3) During storage, batteries should be placed correctly according to the labeling on the packaging box. Inverted, lateral, or tilted placement is strictly prohibited. When stacking, compliance with the stacking requirements specified on the outer packaging is mandatory.
- 4) During storage, batteries should be kept separately to avoid mixing with other devices and excessive stacking. When storing a large number of batteries on-site, it is recommended to have fire-fighting facilities that meet requirements, such as fire sand and fire extinguishers.

Caution:

- 1) Batteries should be used promptly. For batteries stored for extended periods, regular recharge treatment is recommended to prevent damage.
- 2) The storage environment must comply with local regulations and standards.
- 3) Store in a clean, dry, and well-ventilated area, and protect from dust and moisture exposure. Avoid exposure to rainwater or standing water.
- 4) The ambient air must not contain corrosive or flammable gases.
- 5) Storage environment requirements:
 - a. Ambient temperature: -10°C to 45°C ; recommended storage temperature: 10°C to 30°C .
 - b. Relative humidity: 5%RH to 95%RH.
- 6) During extended storage, the product must undergo inspection and testing by qualified professionals before being put into use.
- 7) During storage, relevant documentation compliant with product storage requirements must be retained, including temperature and humidity log data, storage environment photographs, and inspection reports.
- 8) The first-in-first-out principle shall be followed during battery shipment.
- 9) The storage duration is calculated from the last charging time indicated on the battery packaging, and the time is updated after charging.

3.3. Battery Recharge

Battery Incoming Inspection

The battery must be labeled with a recharge label on its outer packaging box. The recharge label should indicate the last charging time and the recommended next charging time for the battery.

Battery Recharging Requirements

- 1) The warehouse administrator shall conduct monthly statistics on battery storage conditions, regularly report battery inventory status to the planning department, and arrange replenishment charges promptly based on storage duration.
- 2) After battery production testing is completed, the state of charge (SOC) must be replenished to at least 30%-40% before storage.

Expiry Storage Judgment Condition

In principle, long-term storage of batteries is not recommended, as prolonged deep discharge can lead to battery damage. Batteries should be used promptly. Stored batteries must be handled in accordance with the following requirements.

Planned storage time	Actual Storage Temperature	Recharge Cycle	Remarks
1 Month	$T \leq -10^{\circ}\text{C}$	Not allow	Before battery storage, the SOC should be controlled between 30% and 40%.
Within 1 Year	$-10^{\circ}\text{C} < T \leq 25^{\circ}\text{C}$	15 months	
Over 1 Year	$25^{\circ}\text{C} < T \leq 35^{\circ}\text{C}$	9 months	

Table 3-1 Recommended Power Supply Cycle

- 1) Batteries exhibiting deformation, damage, or leakage shall be directly Disposed or recycled within local requirements without considering storage duration.
- 2) The storage duration is calculated starting from the most recent charging time indicated on the battery's external packaging recharge label. After the battery passes the recharge test, the most recent charging time on the label and the next charging time (next charging time = most recent charging time + recharge cycle) will be updated.
- 3) A maximum of three storage recharge cycles is permitted, or the battery may remain unused for up to three years. If either limit is exceeded, the battery is recommended to be retired from service.
- 4) Long-term storage of lithium batteries results in capacity loss, with the extent of loss increasing proportionally to storage duration. If customers conduct discharge tests according to specification documents, batteries with post-storage capacity below 100% of rated capacity may fail the test.

Inspection before recharge

- 1) Prior to battery recharge, visual inspection of the batteries must be conducted. Only batteries that pass the inspection can proceed to the recharge process, while non-compliant batteries shall be Disposed or recycled within local requirements.
- 2) If the battery exhibits any of the following conditions, it shall be deemed non-compliant with the appearance inspection requirements.
 - Battery deformation
 - Battery casing damage
 - Battery liquid leakage

Note:

- 1) The charging process must be monitored on-site by personnel to prevent any abnormal phenomena.
- 2) If abnormal phenomena such as bulging or smoking occur during charging, immediately stop charging and the battery shall be Disposed or recycled within local requirements.
- 3) Recharge operations must be performed by trained professionals.
- 4) During power replenishment, it is recommended to maintain the battery SOC at 40%. Long-term storage may lead to capacity loss, with lithium batteries typically experiencing irreversible capacity loss of 3% to 10% after 12 months of storage at recommended temperatures.

Recharge Steps:

Step 1 Complete system wiring and ensure correct cable connections.

Step 2 First close the "DC SWITCH", then press the power button.

Step 3 Close the AC switch between the inverter and the power grid.

Step 4 Monitor the POWER indicator light on the inverter's LCD screen and confirm it turns red.

Step 5 Ensure that all battery modules at charge statuses.

Step 6 Complete charging when the SOC battery level indicator stops blinking or the app displays 'Charging Complete'.

Step 7 After completing charging, disconnect the AC switch between the inverter and the power grid, then turn off the DC SWITCH for energy storage. If additional battery charging is required, repeat the above wiring and charging steps.

4. Energy Storage Installation

4.1. Unpacking and Packaging Contents Inspection

Please ensure that the following items are included in the packaging with your machine:

Low Voltage Control Module Packing List					
Order number	name	Packaging location	quantity	unit	remarks
1	Physical Implementation of Low-Voltage Control Module	Low-voltage control module	1	PCS	
2	Physical base	Low-voltage control module	1	PCS	
3	Mounting bracket	Low-voltage control module	2	PCS	
4	Expansion bolt	Low-voltage control module	2	PCS	
5	Product installation screws	Low-voltage control module	2	PCS	
6	B+ to PCS power harness	Length: 2m Placed in the low-voltage control module	1	PCS	
7	B-to-PCS Power Harness	Length: 2m Placed in the low-voltage control module	1	PCS	
8	PCS Communication Harness	Length: 2m Placed in the low-voltage control module	1	PCS	
9	Ground lead	Length: 2m Placed in the low-voltage control module	1	PCS	
10	Quick Assembly Manual	Placed in the low-voltage control module	1	PCS	
11	Product specification	Placed in the low-voltage control module	1	PCS	
12	Warranty Card	Placed in the low-voltage control module	1	PCS	
13	Packaging list	Placed in the low-voltage control module	1	PCS	
14	Levelling instrument	Placed in the low-voltage control module	1	PCS	

PACK Packing list					
order number	name	Packaging location	quantity	unit	remarks
1	PACK material object	PACK	1	PCS	
2	Product installation screws	PACK	2	PCS	
3	Packaging list	PACK	1	PCS	

4.2. Tools Required for Installation



4.3. Installation Requirements

Installation angle requirements

Energy storage supports both ground-mounted and wall-mounted installations. Installation angle requirements:

Energy storage systems must not be installed in forward, horizontal, inverted, backward, or side-tilted positions.

Installation location requirements

For installation locations, select solid brick-concrete structures, concrete walls, and floors. If other types of walls or floors are chosen, they must be constructed with flame-retardant materials and meet the equipment load-bearing requirements.

Equipment installation environment requirements

When selecting a foundation site, please follow these principles:

- 1) It should be installed in a dry and well-ventilated environment to ensure effective heat dissipation.
- 2) It is recommended to select installation locations with shading or to construct sunshades.
- 3) Avoid direct sunlight or rain exposure, maintain a clean surrounding environment, and ensure the absence of excessive infrared radiation, organic solvents, or corrosive gases.
- 4) Install in a location away from fire sources.
- 5) The installation area is off-limits to children.
- 6) The installation location should be away from water sources such as faucets, drainage pipes, and sprinklers.
- 7) The product cabinet shall be securely mounted on walls or other load-bearing fixtures to prevent tipping over.
- 8) The outdoor unit is recommended to be installed under eaves or in garages, while the indoor unit should be placed in a location protected from rain exposure.
- 9) The device requires a sturdy, flat support surface.
- 10) Do not place flammable or explosive materials around the equipment.
- 11) Do not block ventilation openings or cooling systems while the equipment is in operation to prevent fires caused by high temperatures.
- 12) Do not place the device in environments with flammable or explosive gases or smoke, and do not perform any operations.

Environmental temperature requirements

No special environmental temperature requirements apply during installation. However, the battery will only operate within its specified operating temperature range. When the ambient temperature falls below this range (e.g., -20°C), the battery will not perform any charging or discharging. Only when a charge request is received will the battery activate its internal heating logic to raise its temperature to 10°C . Please refer to Section 2.5.

Storage space requirements

- 1) During installation of energy storage systems, ensure there are no other devices (except Solis-related equipment and sunshades) or flammable/explosive materials nearby. Sufficient space must be reserved to meet heat dissipation and safety isolation requirements.
- 2) When installed on walls, no items should be placed below the energy storage unit.
- 3) At least 800 mm of working space and single-person passage width must be reserved in front of the battery.

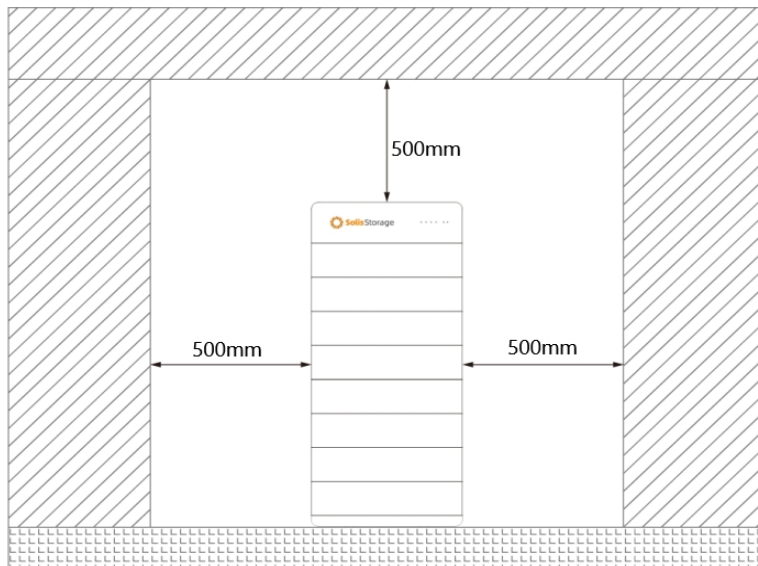

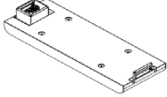

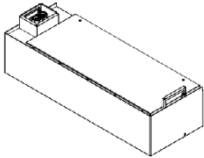



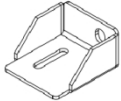

Figure 4-1 Installation Space Requirements Diagram





4.4. Energy Storage Installation

Please verify the following component list to ensure all accessories are complete. The table below shows the complete battery module accessories including one Pack. Select the appropriate configuration based on actual shipment conditions during equipment installation.

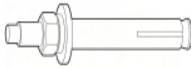
Controller and Base			
			
controller	lampstand	4x leveling feet	4xM5*12 Screw with a plum blossom head

Battery pack and accessories			
			
battery pack	2xM5*12 Screw with a plum blossom head		

Support bracket accessory kit			
			
2xPack package fixing block	2xM6*12 External hex screw	2xM8*80 expansion bolt	

Support bracket accessory kit			
			
Positive terminal connector harness	Negative terminal connection harness	2x communication cable harness	ground lead

Floor-mounted installation

Step 1: The hole dimensions for ground installation are shown in the figure below.

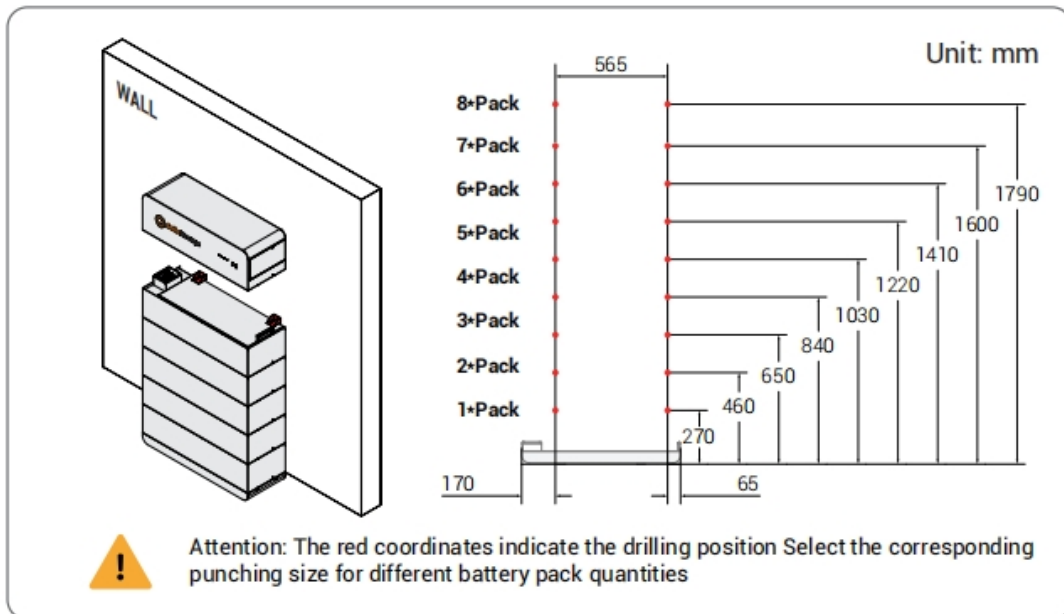
Danger:

Before drilling, make sure to avoid the pre-installed electrical and water lines inside the wall to prevent accidents.

Note:

To prevent dust from entering the respiratory tract or entering the eyes during drilling, operators should wear protective goggles and dust masks.

Use a vacuum cleaner to thoroughly remove dust from both the interior and exterior of all holes, then measure the hole spacing. For holes with significant errors, reposition and re-drill them.

After removing the nut, spring washer, and flat washer, the upper surface of the expansion joint must be flush with the cement wall or floor, without protruding from the surface. Otherwise, the installed components may be misaligned on the wall or floor.

For the expansion bolt below, simply loosen the nut, spring washer, and flat washer appropriately without removing them entirely.

Red markers indicate the drilling positions. Select the appropriate drilling size based on the number of battery packs.

The M8×80 expansion bolts provided with the package are for on-site installation. If the length or quantity does not meet installation requirements, please provide your own M8 stainless steel expansion bolts. These bolts are primarily used for solid brick-concrete wall structures and concrete floors. For installation in other wall or floor types, ensure load-bearing requirements are met and select alternative installation bolts accordingly.

Step 2: Align the floor-mounted base with the wall surface, ensuring the base is 10mm to 15mm away from the wall surface. Mark the base placement area with a marker pen. Then align the marking lines on the template with the base surface to determine the wall drilling positions for the fixed control module, and mark these locations with a marker pen.

Step 3: Place the base in a safe area. Use an impact drill to perform positioning drilling according to the marked position points. After completing the required clearance drilling, reposition the base in the designated area.

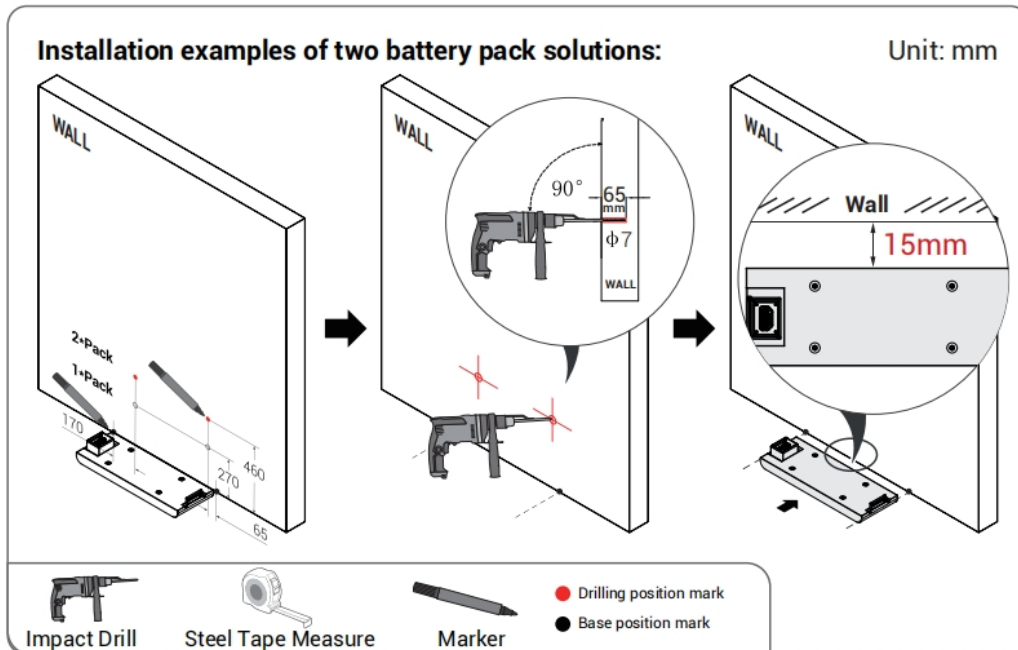

Step 4: Align the four sides of the first battery module with the four sides of the base, and gently place it on the base to ensure no damage to the protruding parts. After completing the positioning, install the side fixing screws.

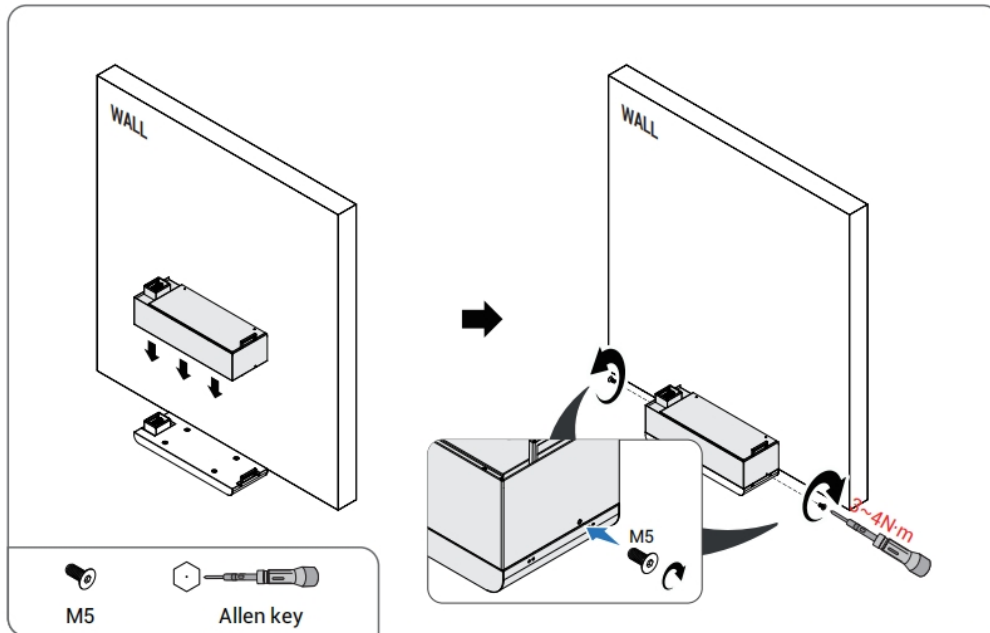

Step 5: Install the remaining battery modules sequentially from bottom to top according to Step 4, and secure the screws on both sides.

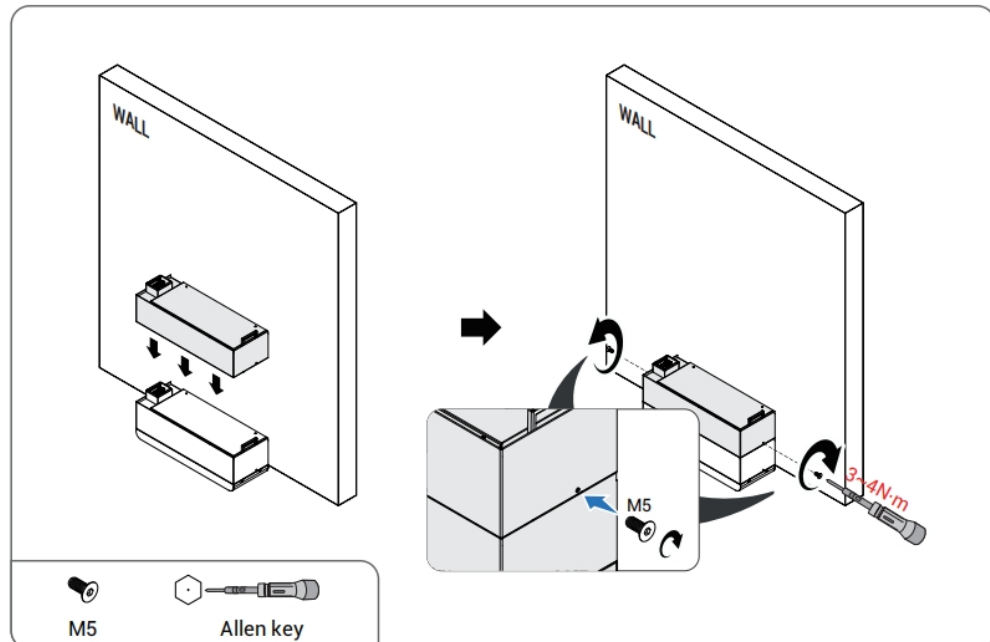

Step 6: After installing the topmost battery pack, install the mounting bracket.

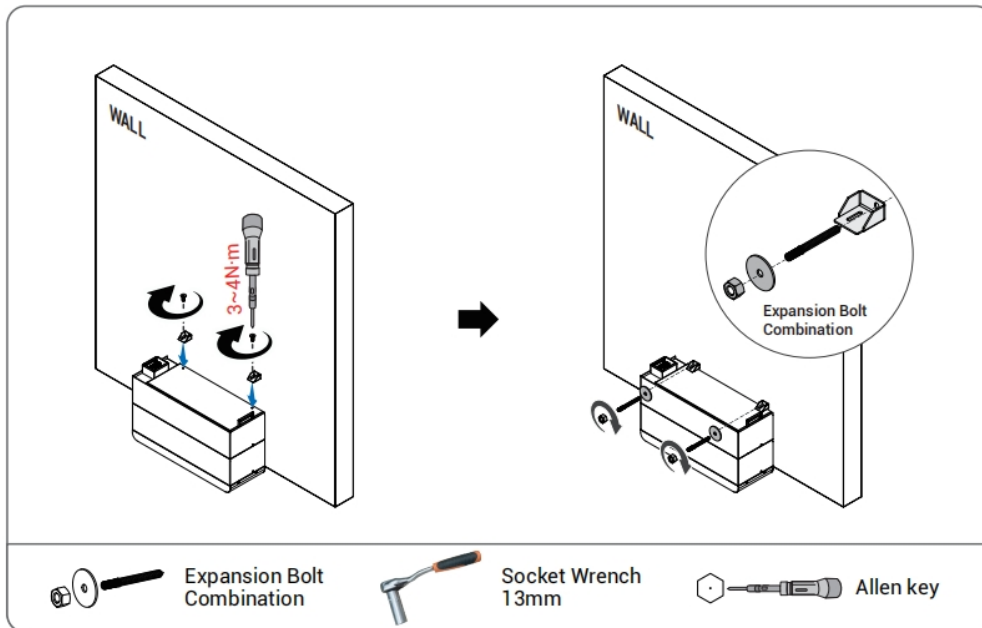

Step 7: Install the wiring harness, where red corresponds to the positive terminal of the junction box and black to the negative terminal. Connect the terminals using the quick-connect connectors on the harness in a one-to-one correspondence. Secure the ground wire by screwing it into the grounding port, and finally tighten the cover plate.

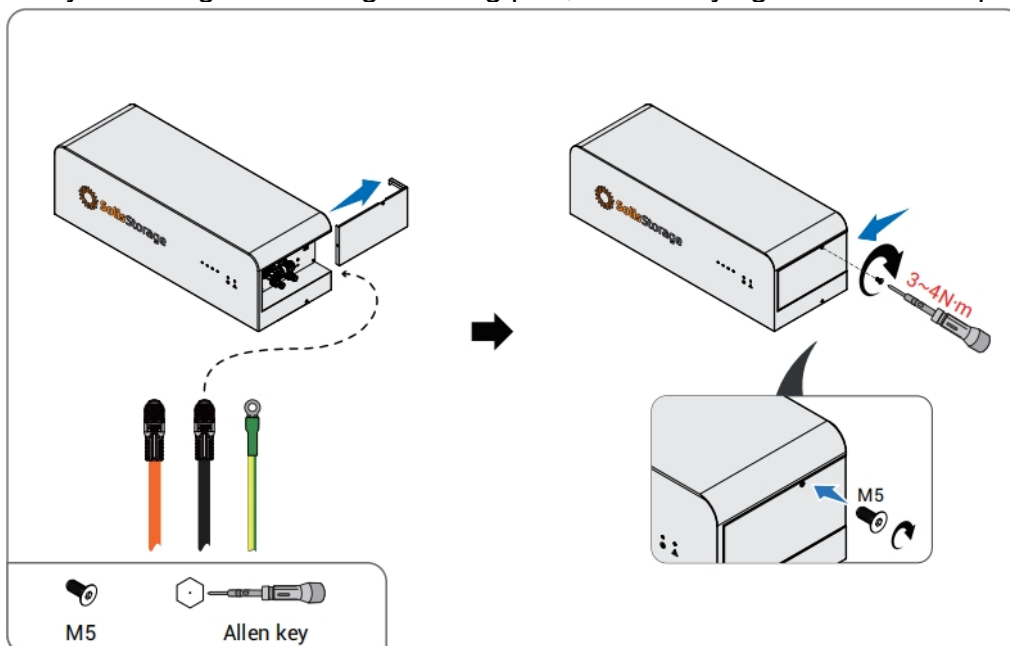

Warning:

Before connecting the wiring harness, ensure the junction box switch is in the OFF position to prevent equipment damage caused by operational errors.

Ensure proper insulation protection before connecting the other end of the wiring harness.

Step 8: Align the connection box with the four sides of the battery pack according to the diagram, and gently place it on the battery pack to ensure no damage to the protruding parts. After completing the positioning, install the side fixing screws.

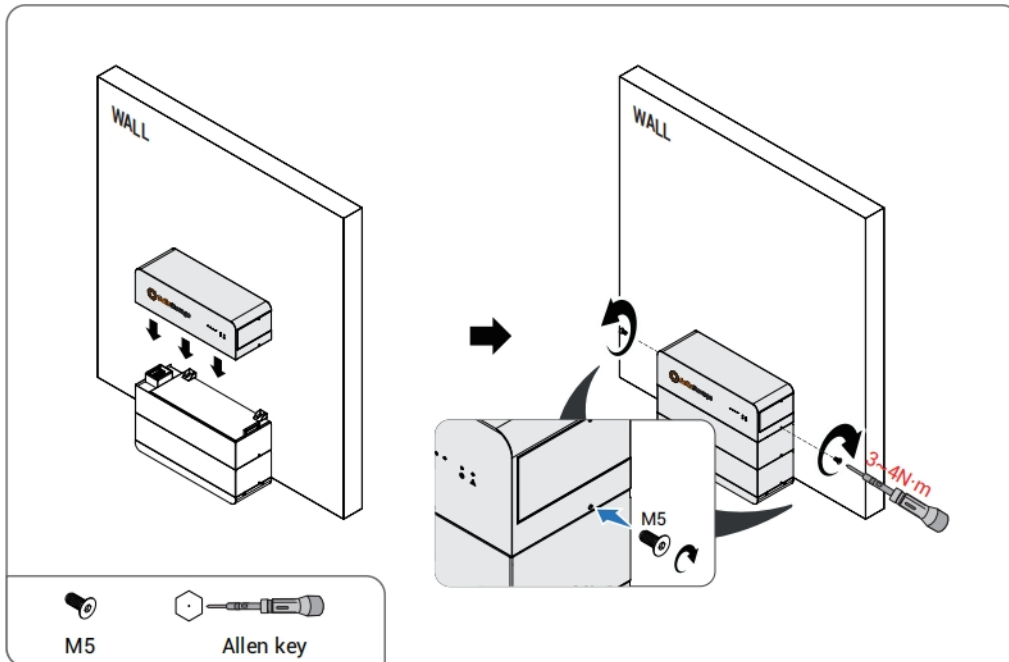

Wall-mounted installation

Danger:

Before drilling, make sure to avoid the pre-installed electrical and water lines inside the wall to prevent accidents.

Note:

To prevent dust from entering the respiratory tract or entering the eyes during drilling, operators should wear protective goggles and dust masks.

Use a vacuum cleaner to thoroughly remove dust from both the interior and exterior of all holes, then measure the hole spacing. For holes with significant errors, reposition and re-drill them.

After removing the nut, spring washer, and flat washer, the upper surface of the expansion joint must be flush with the cement wall or floor, without protruding from the surface. Otherwise, the installed components may be misaligned on the wall or floor.

For the expansion bolt below, simply loosen the nut, spring washer, and flat washer appropriately without removing them entirely.

Red markers indicate the drilling positions. Select the appropriate drilling size based on the number of battery packs.

The package includes M8×80 expansion bolts. If the length or quantity is insufficient for installation requirements, please provide your own M8 stainless steel pull-type expansion bolts. These expansion bolts are primarily used for solid brick-concrete wall structures and concrete floors. For installation in other wall or floor types, ensure load-bearing requirements are met and select appropriate installation bolts accordingly.

Step 1: The dimensions of the suspended mounting holes are shown in the figure below.

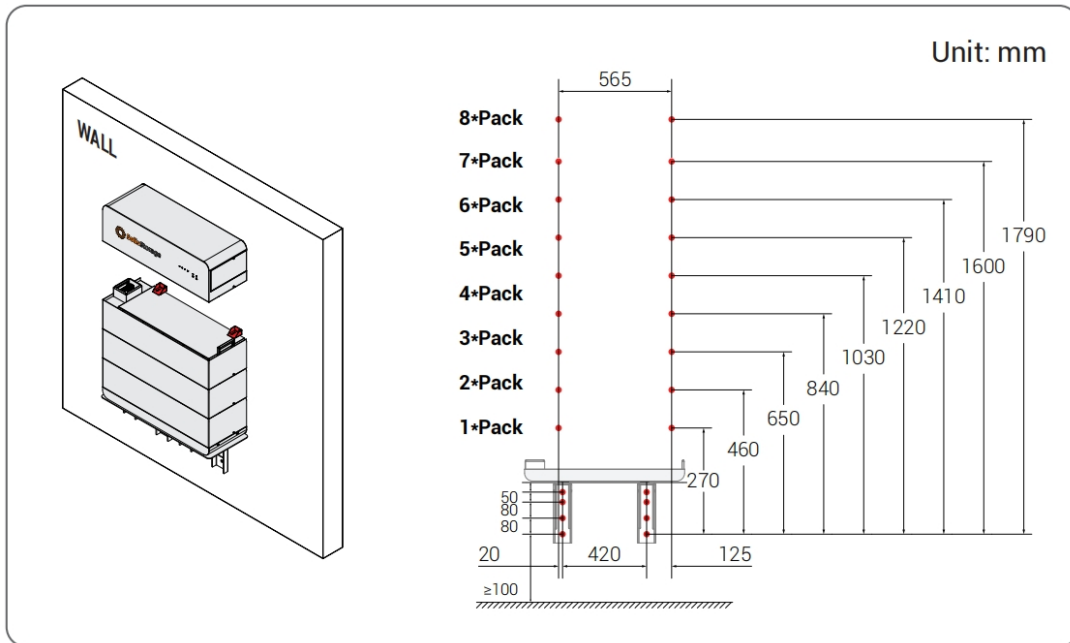

Step 2: Locate and drill holes, then install the base. According to the hole dimension diagram in Step 1, mark the hole positions for the base mounting bracket and the mounting holes for the control module on the wall, and label them with a marker pen.

Step 3: Based on the delineated positional points, perform positioning drilling using a percussion drill. After completing the required voids, install the base support bracket in the designated area.

Step 5: Align the four edges of the first battery module with the four edges of the base, then gently place it on the base to avoid damaging the protruding parts. After positioning, install the side fixing screws, followed by sequentially installing the remaining battery modules from bottom to top and securing the side screws.

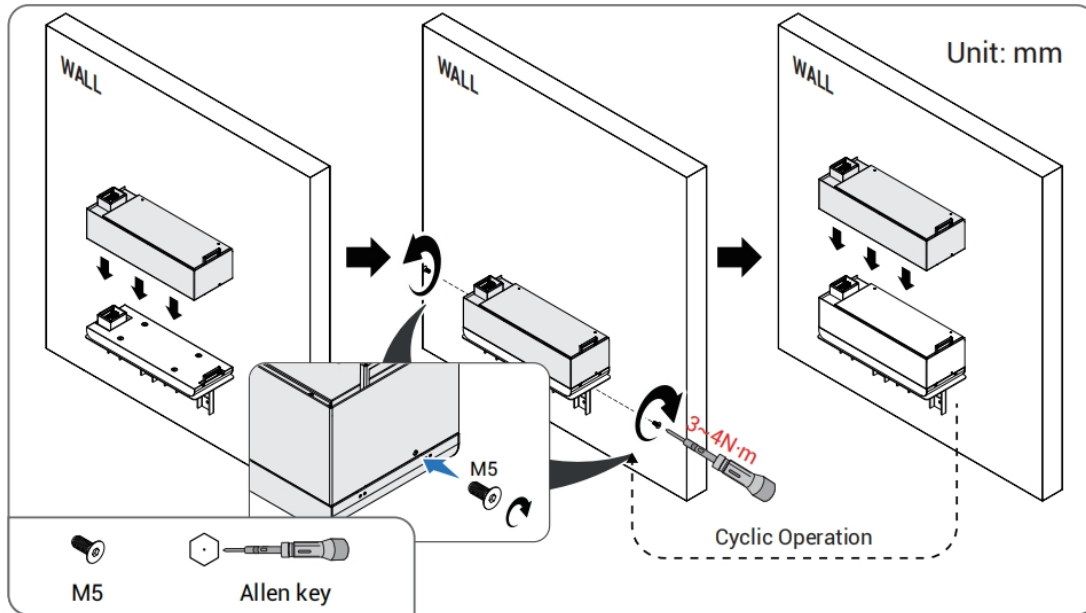

Step 6: After installing the topmost battery pack, install the mounting bracket.

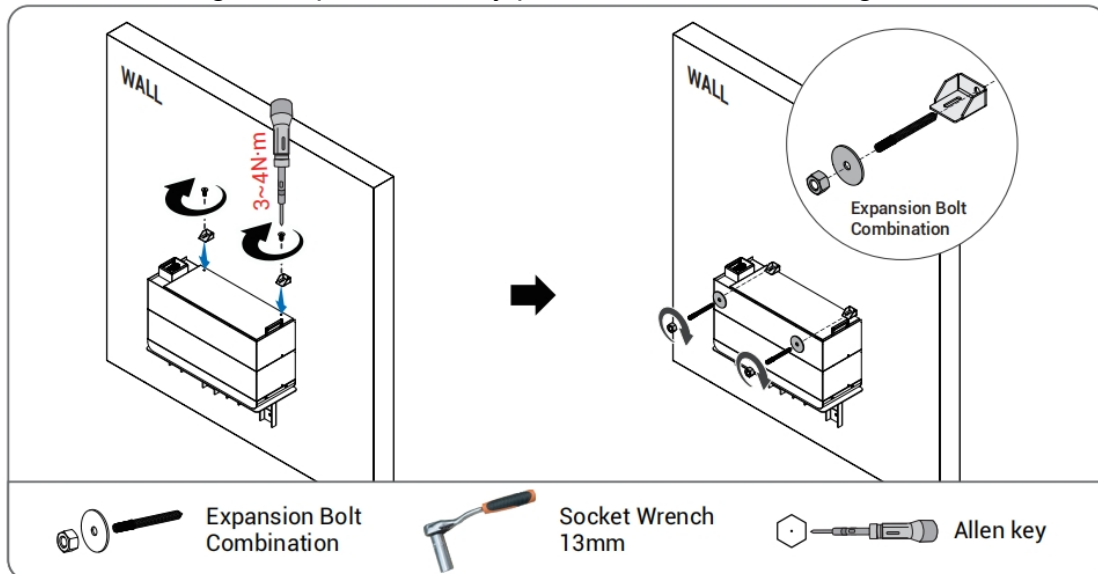

Step 7: Install the red terminal of the wiring harness into the positive terminal of the corresponding junction box, and the black terminal into the negative terminal. Connect them using the quick-connect connectors on the wiring harness in a one-to-one correspondence. Secure the ground wire by screwing it into the grounding port, and finally tighten the cover plate.

Step 8: Align the connection box with the four edges of the battery pack according to the diagram, then gently place it on the battery pack to avoid damaging the protruding parts. After positioning, install the side fixing screws.

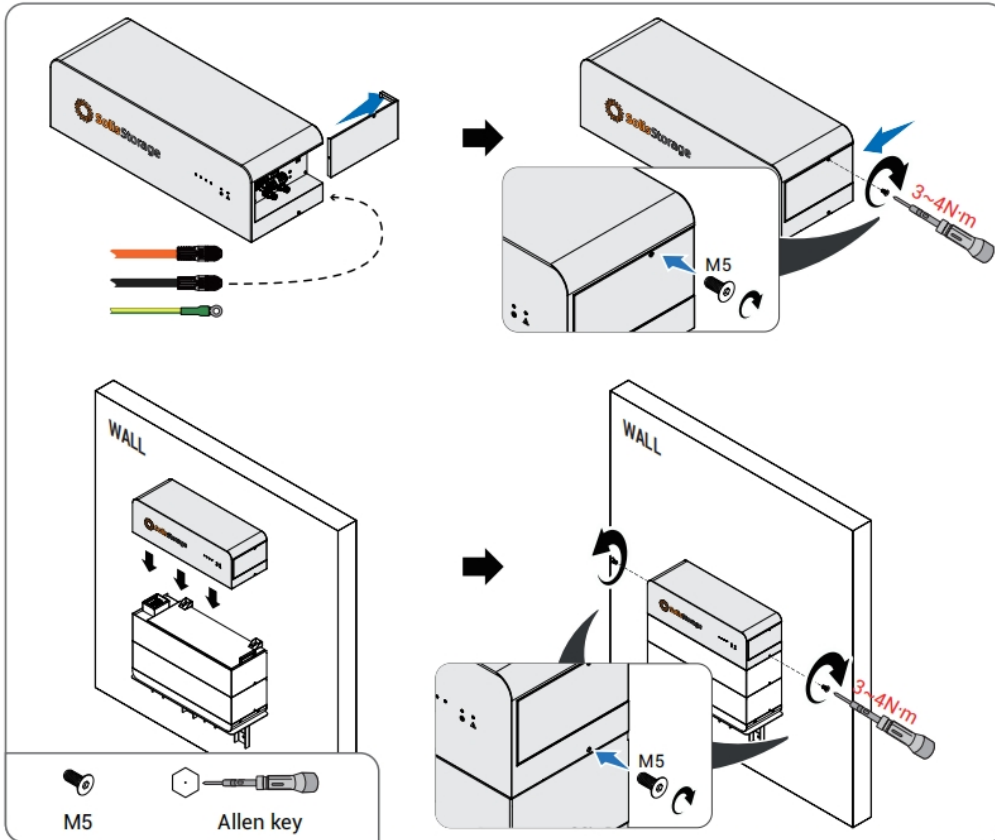

Parallel installation

The energy storage system should be arranged systematically according to the project design specifications, and installation should follow the 'ground-mounted installation/suspended installation' method based on the designed assembly approach.

Note:

The energy storage system employs natural cooling. Maintain a minimum 0.5-meter clearance between cabinets to prevent overheating and ensure optimal performance.

5. Electrical Connection

Danger:

Before making electrical connections, ensure that the "DC SWITCH" of the energy storage system and all switches connected to it are in the "OFF" position. Otherwise, the high voltage from the energy storage system may cause an electric shock hazard.

During battery installation, pay attention to the positive and negative terminals. It is strictly forbidden to short-circuit the positive and negative terminals of a single battery or a battery string, otherwise it will cause a battery short circuit.

- 1) Smoking or open flames are prohibited near batteries.
- 2) Use dedicated protective equipment and specialized insulating tools to prevent electric shock injuries or short-circuit faults.

Warning:

- 1) Equipment damage caused by incorrect wiring is not covered under the warranty.
- 2) Electrical connection operations must be performed by qualified electrical technicians.
- 3) When performing electrical connections, operators must wear personal protective equipment.
- 4) According to the torque specified in the text for tightening the fastening screws of copper bars or cables, conduct regular inspections to verify whether the screws are properly tightened, and check for rust marks, corrosion, or other foreign objects. Clean any contaminants if found. Failure to do so may result in loose connections, leading to excessive voltage drop in the circuit. Under high current conditions, this could cause significant heating and even battery damage.
- 5) During battery installation, it is strictly prohibited to place installation tools, metal parts, or debris on the battery. After installation completion, promptly clean the battery surface and surrounding areas.

Caution:

- 1) It is prohibited to connect two or more cables in parallel at the power interface of battery positive and negative terminals.
- 2) During cable production, maintain a safe distance from equipment to prevent accidental entry of cable debris into machinery, which may cause sparks leading to personal injury or equipment damage.





Note:

The cable colors shown in all electrical connection diagrams in this chapter are for reference only. Cable selection must comply with local cable standards (yellow-green dual-color wires are exclusively permitted for protective grounding).

5.1. Install the power cable and protective grounding cable

Wiring Harness Introduction

The power harness, communication harness, and grounding wire required for the energy storage system have been pre-manufactured and shipped with the energy storage cabinet. For wiring installation and connection, please use the corresponding harnesses.

Diagram of auxiliary wiring harness			
			
Positive terminal connector harness 1/0AWG (50mm ²)	Negative terminal connection harness 1/0AWG (50mm ²)	2x communication cable harness 24AWG (0.22mm ²)	ground lead 4AWG (25mm ²)

Cable Harness Preparation

- 1) Take out the positive and negative power cables from the battery pack accessories (one end with a quick connector, the other end with a stripped/bare wire).
- 2) Take out the OT terminals from the inverter accessory kit or prepare your own (OT70-6).
- 3) Prepare heat shrink tubing (red and black).
- 4) When stripping the insulation from the bare wire ends of the positive and negative power cables, ensure that the conductor is not damaged.
- 5) The bare wire ends shall be crimped with OT terminals on site (as shown in the figure).

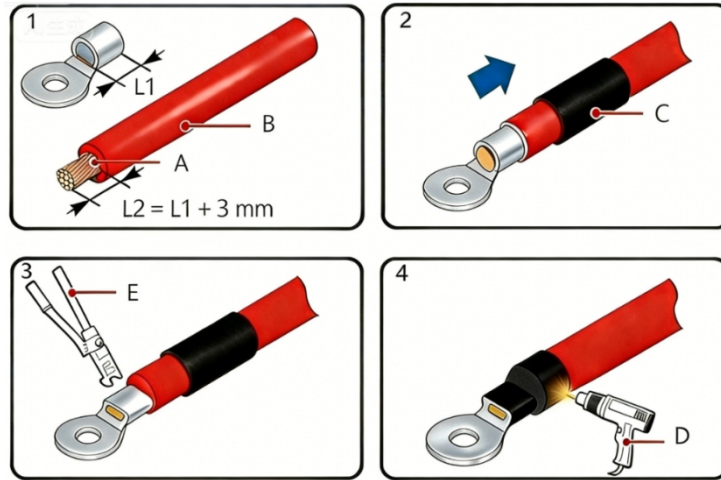
Terminal Crimping

Code	Components	Code	Components
A	Conductor	D	Heat Gun
B	Insulation Layer	E	Hydraulic Crimping Tool
C	Heat Shrink Tubing		

Note:

- 1) After crimping, the conductor crimp barrel of the OT terminal shall completely wrap the conductor, and the conductor shall be firmly connected to the OT terminal without looseness.
- 2) Heat shrink tubing or insulating tape may be used to cover the crimped section.
- 3) The specifications of the cable and heat shrink tubing used shall be determined according to the actual type of cable harness being fabricated.
- 4) When using a heat gun, take appropriate protective measures to prevent burns to personnel or damage to the equipment.

Electrical Wiring

- 1) The selected cables must meet the following requirements:
- 2) The minimum cable cross-sectional area shall comply with local cable standards.
- 3) Factors affecting cable selection include rated current, cable type, installation method, ambient temperature, and the maximum allowable cable loss.
- 4) The length of the DC input cable and signal cable between the energy storage system and the inverter shall be no more than 10 m.
- 5) Flame-retardant cables must be used.

The interfaces shown below represent all functional interfaces of the system. The actual product may vary depending on its configuration. Please connect the cables according to the corresponding labels on the purchased product.

Caution:

The cables used shall comply with local legal and regulatory requirements.

The cable colors shown in this manual are for reference only. Select cables according to local cable standards.

Note:

Strain-relief mechanism cable gland used. When installing, ensure that the PE cable is at least 2 cm longer than the power cable.

The OT terminal block of the inverter wiring must accommodate aluminum or copper conductors.

Battery Module Interface	Interface	Explain
B+	Connect to the Inverter positive terminal interface	Positive output of battery module
B-	Connect to the Inverter negative terminal interface	Negative electrode output of battery module
LINK IN	Connect the CAN interface of the Inverter	Communication Interface Between Battery Module and Inverter
LINK OUT	The LINK IN interface of the slave battery	Network Communication
	Ground System	Energy storage equipment grounding point

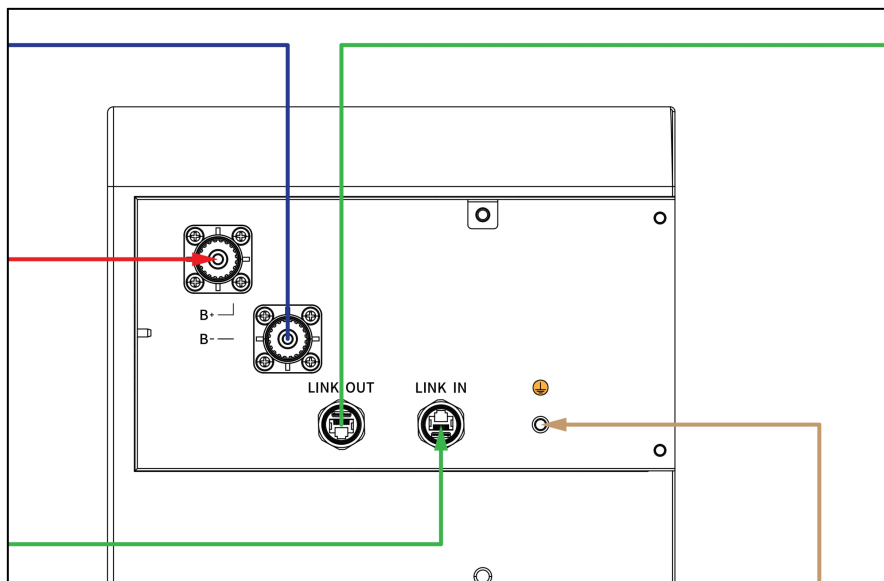

Figure 5-1 Wiring Interface

5.2. Single-machine system parallel configuration guide:

Prerequisites:

1. Confirm that the maximum voltage difference between battery packs is $<1.5V$. If the voltage difference is $\geq 1.5V$, perform discharge or charge operations on the battery packs first.
2. Ensure that the battery packs are securely installed, all electrical connections are correct, and the environmental conditions meet the requirements.

Single system configuration steps

Step 1: Single-system assembly: Confirm the number of battery packs within a single system (2-8 units), connect power terminals via internal parallel boards/cables, and ensure secure connections with correct polarity.

Step 2: Power line connection: Connect the system's power output positive and negative terminals to the inverter's designated ports.

Step 3: CAN communication cable connection: Use shielded twisted pair cable to connect the CAN communication cable from the LINK-IN terminal block to the inverter's designated BMS port.

Automatic Address Assignment Description

1) Upon power-on, the system automatically allocates logical addresses via 485 bus negotiation (e.g., System 1 as Master, Systems 2-4 as Slaves 1-3), with the battery pack connected to the inverter's junction box defaulting to Master status.

User operation: Ensure proper physical connection, wait 1-3 minutes after power-on, and check address allocation completion status via indicator light (or APP).

5.3. Multi-system Parallel Configuration Guide

Prerequisites:

3. Confirm that the maximum voltage difference between battery packs is $<1.5V$. If the voltage difference is $\geq 1.5V$, perform discharge or charge operations on the battery packs first.
4. Ensure that the battery packs are securely installed, all electrical connections are correct, and the environmental conditions meet the requirements.

Parallel configuration steps

Step 1: Single-system assembly: Confirm the number of battery packs within a single system (2-8 units), connect the power terminals via internal parallel boards/cables, and ensure secure connections with correct polarity.

Step 2: Inter-system parallel connection

1. Power line parallel connection: Connect the positive terminals of power outputs from all systems to be paralleled, and the negative terminals to a unified DC busbar or designated ports of the inverter.
2. Hand-in-hand connection of communication lines (485): Use shielded twisted pair cables to connect System A's 485-A terminal to System B's 485-A terminal, and 485-B to 485-B terminal, then sequentially connect all systems.

Step 3: Inverter connection: Connect the final combined positive and negative power lines to the battery input port of the energy storage inverter. Figure 5-4 Schematic diagram of multi-unit wiring

Note:

Future iterations of this product might not be backwards compatible and there might be implications when putting multiple products of different versions in the same system. Please consult the local team to verify compatibility between generations.

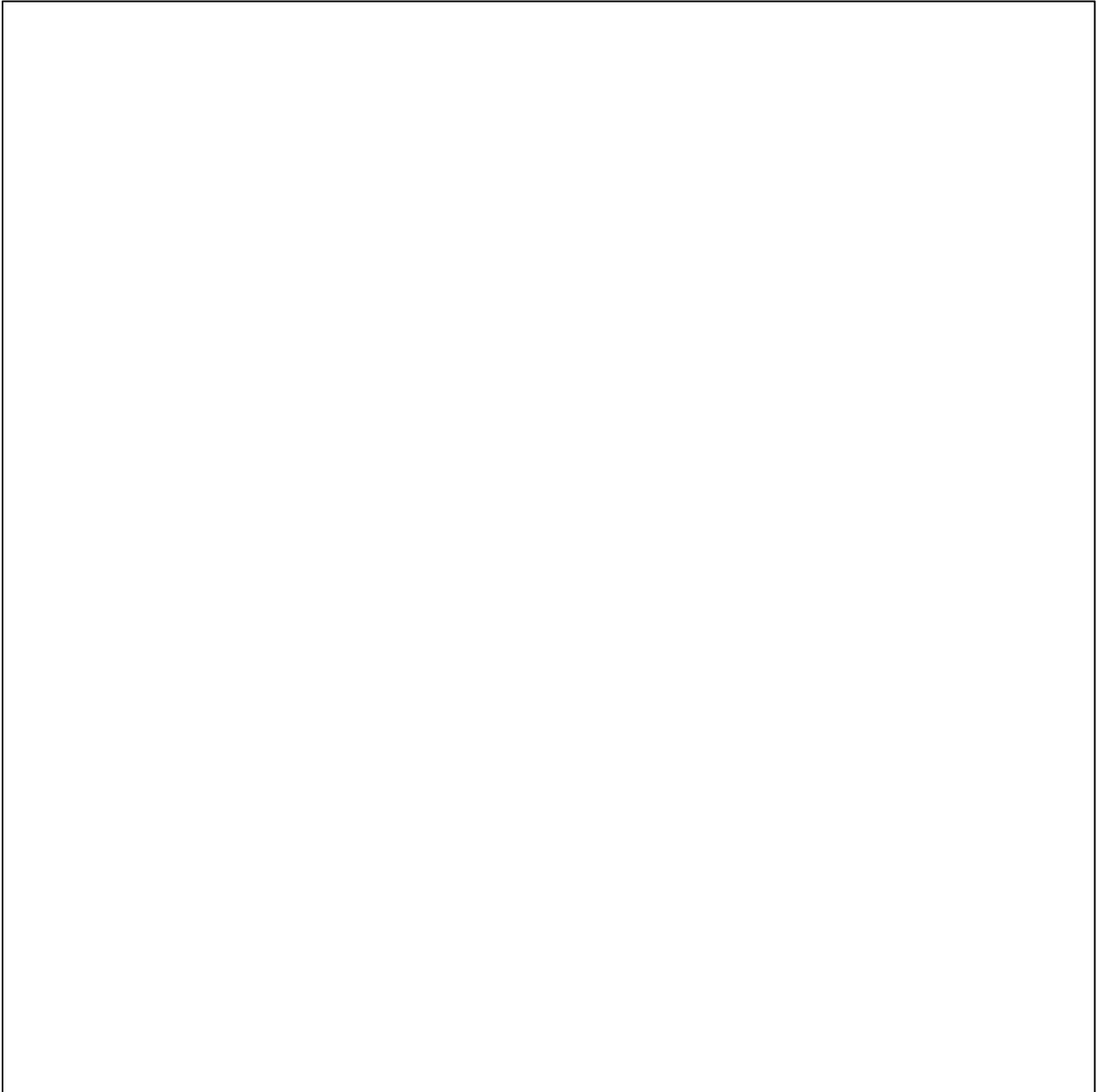

Automatic Address Assignment Description

- 1) Upon power-on, the system automatically allocates logical addresses via 485 bus negotiation (e.g., System 1 as Master, Systems 2-4 as Slaves 1-3), with the battery pack in the inverter's junction box defaulting to Master status.
- 2) User operation: Ensure proper physical connection, wait 1-3 minutes after power-on, and check address allocation completion status via indicator light (or APP).

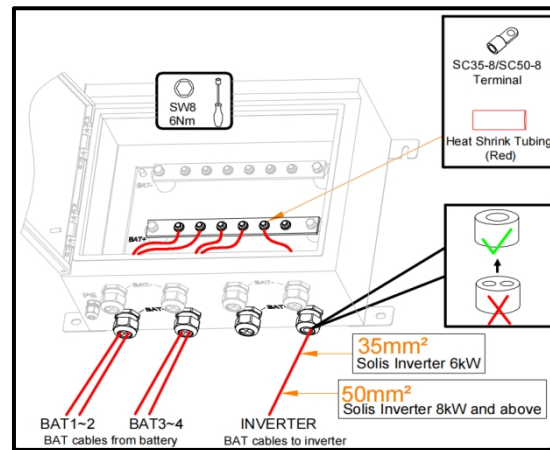
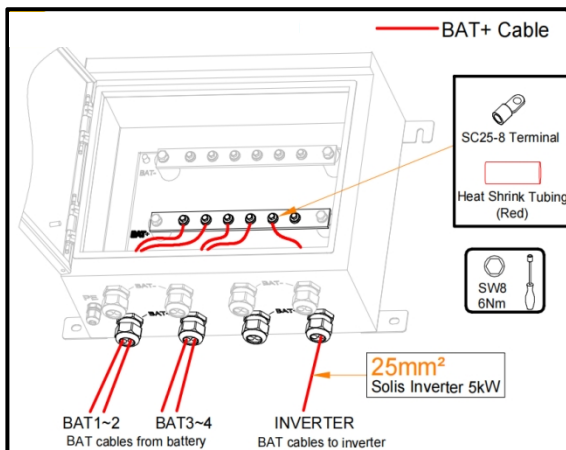
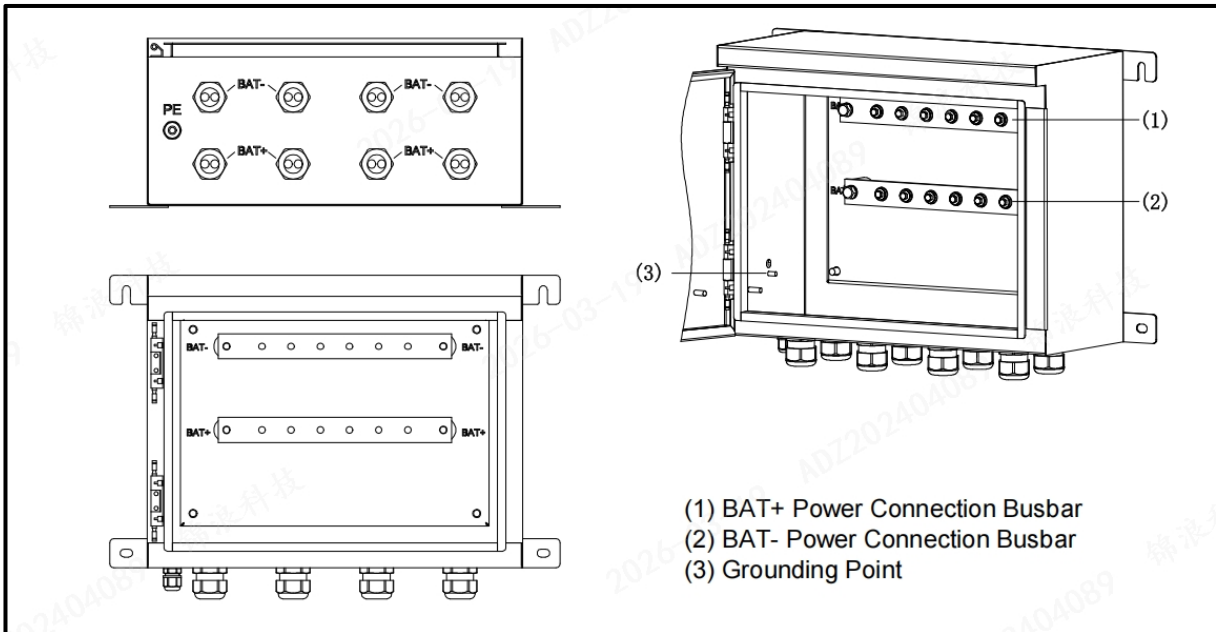
5.4. Standard Combiner Box

The combiner box has 8 terminals. Since the number of terminals and their aperture sizes are fixed, the number of connectable cables varies depending on the cable size. When the cable size is 25 mm², each terminal can accommodate two cables. When the cable size is 35 mm² or 50 mm², each terminal can accommodate only one cable. For the number of batteries that one combiner box can support, please refer to the table below.

FlexHome- (5-40) kWh-L	
with Combiner Box	3 units
Note	only for ≤10kW Hybrid inverter

5.5. Recommendation Configuration

	FlexHome-(5-40)kWh-L	Corresponding ARM Version
S6-EH1P5K-L-PLUS	2*5kWh	2C14
S6-EH1P6/8K-L-PLUS	3*5kWh	2C14
S6-EH1P10K-L-PLUS	4*5kWh	2C14
S6-EH1P12K03-NV-YD-L	2*3*5kWh	2C14
S6-EH1P16/18K03-NV-YD-L	2*4*5kWh	2C14
S6-EH3P8K02-NV-YD-L 2*BATT Ports	2*5kWh	0D06
S6-EH3P10K02-NV-YD-L 2*BATT Ports	2*2*5kWh (no combiner required)	0D06
S6-EH3P12/15K02-NV-YD-L 2*BATT Ports	2*3*5kWh (no combiner required)	0D06
S6-EH3P18K02-NV-YD-L 2*BATT Ports	2*4*5kWh (no combiner required)	0D06
Data logger		100141D9
<p>Note: Make sure that the inverter's ARM version is at least this version (or newer)</p>		

5.6. Inverter and datalogger FW requirements

Read before installation:

When installing Ginlong energy storage batteries and pairing them with Ginlong inverters, first check the software version numbers of the inverter and the data acquisition stick to ensure that both the inverter and the data acquisition stick meet or exceed the following version numbers.

Inverter Model	Inverter Software Version (First Edition)			Inverter Model	Inverter Software Version (First Edition)		
	ARM	DSP	LCD		ARM	DSP	LCD
S5-EH1P(3-6)K(-Smart)				S6-EH3P(12-20)K- (ND) -H			
S6-EH1P(3-6)K-L-EU/AU				S6-EH3P(8-12)K-LV-ND-H			
S6-EH1P(3-8)K-L-PRO				S6-EA1P(3.6-6)K-L			
S6-EH1P(3-10)K-L-PLUS	V2C-14	V1708	V0F08	S6-EA3P(5-10)KAA-NV-ND-H			
S7-EH1P(3-6)K02-NV-YD-L				S6-EA3P(5-10)KAA-NV-YD-H-PRO			
S7-EH1P(8-12)K02-NV-YD-L				S6-EO1P(4-5)K-48-EU			
S6-EH1P(9.9-18)K03-NV-YD-L				S6-EH3P(29.9-60)K-H - (21A)			
S6-EH2P(5-8)K02-SV-YD-L				Accessories&Monitoring			
S6-EH2P(9.6-16)K03-SV-YD-L-US				Model	Software Version (First Edition)		
S6-EH3P(5-18)K02-NV-YD-L	V0E-05	0F05	V0B04	S2-WL-ST	100141D9		
S6-EH3P(7-10)K02-LV-YD-L	V0E-05	0F05	V0B04	S1-W4G-ST			
S6-EH3P(3-12)K-H				S5-WiFi-ST			
S6-EH3P(12-20)K- (ND) -H				-	-		

6. System Configuration and Startup

The Settings and information of the battery are all through the Solis inverter. No additional settings are required for the battery during system configuration, just connect the communication cable properly, and the Solis inverter will automatically recognize solis battery and automatically set default parameters (overdischarge SOC, Forcecharge SOC, etc.). For more parameters, please refer to the inverter manual. If you want to set the battery parameters by yourself, you can do so through the battery settings interface of the inverter (Soliscloud APP or WEB).

Caution:

- 1) During battery charging, observe the process continuously. If any abnormal phenomena are detected, immediately disconnect the battery and identify the cause. Continue charging only after resolving the issue.
- 2) After battery installation and testing, when power is cut off or the battery is fully discharged, recharge it promptly to prevent damage from over-discharge.

Before the device is powered on for the first time, parameters must be correctly configured by a qualified technician. Incorrect settings may cause the device to fail to meet the grid connection requirements of the country/region, affecting its normal operation.

6.1. Start-up Inspection

Before powering on the system, double-check the cable routing to ensure all connections are secure and free from short-circuit risks.

Table 6-1 Inspection Items and Acceptance Criteria

No.	Inspection Item	Acceptance Level
1	Energy storage installation completed	The installation is correct and securely reliable.
2	Cable layout is rational	The cable layout is well-designed to meet user requirements.
3	Strapping with zip ties ensures aesthetic binding	The lacing tape should be applied evenly, and no sharp corners should remain at the cut ends.
4	reliable grounding	The ground wire connection is correct and secure.
5	Turn off the switch	The DC SWITCH and all switches connected to the energy storage system are in the OFF state.
6	Cable connection is in place	The DC cable,, and signal cable are correctly and securely connected.
7	Seal unused terminals and interfaces	Unused terminals and interfaces are fitted with waterproof covers.
8	The installation environment meets the requirements	The installation space is well-designed, with a clean and tidy environment free from construction debris.

6.2. Single-system Startup Sequence

Prerequisite conditions: Confirm that the maximum voltage difference between battery packs is $<1.5V$. If the voltage difference is $\geq 1.5V$, perform discharge or charge operations on the battery pack first. 2. Ensure the battery pack is securely installed, all electrical connections are correct, and the environmental conditions meet requirements.

operating steps :

- 1) Closed circuit breaker: Set all system DC output circuit breakers to the "ON" position.
- 2) Press the power button: Hold the button for over 3 seconds until the system indicator light starts flashing slowly, then release the button.
- 3) System self-check: Monitor the indicator light sequence to complete the self-check (typically approximately 30 seconds). Under normal conditions, the indicator light should remain green or display regular slow blinking.
- 4) CAN communication establishment: After completing self-check, the system attempts to establish communication with the inverter via the CAN bus. When the inverter is powered on and in standby mode, communication is established, and the indicator light changes to the "running" state (e.g., blue light remains on).

Note:

The self-check time may be slightly longer after the first startup or prolonged power outage.

6.3. Multi-System Startup Sequence

Prerequisite conditions: Confirm that the maximum voltage difference between battery packs is $<1.5V$. If the voltage difference is $\geq 1.5V$, perform discharge or charge operations on the battery pack first. 2. Ensure the battery pack is securely installed, all electrical connections are correct, and the environmental conditions meet requirements.

operating steps :

- 1) Closed circuit breaker: Set all system DC output circuit breakers to the "ON" position.
- 2) Press the power button: Hold the button for over 3 seconds until the system indicator light starts flashing slowly, then release the button.
- 3) System self-check: Monitor the indicator light sequence to complete the self-check (typically approximately 30 seconds). Under normal conditions, the indicator light should remain green or display regular slow blinking.
- 4) CAN communication establishment: After completing self-check, the system attempts to establish communication with the inverter via the CAN bus. When the inverter is powered on and in standby mode, communication is established, and the indicator light changes to the "running" state (e.g., blue light remains on), while verifying whether all battery packs are online.

Note:

The self-check time may be slightly longer after the first startup or prolonged power outage.

6.4. Communication Protocol and Interface Description

CAN Interface: Baud rate: 9600; supports real-time transmission of system status.

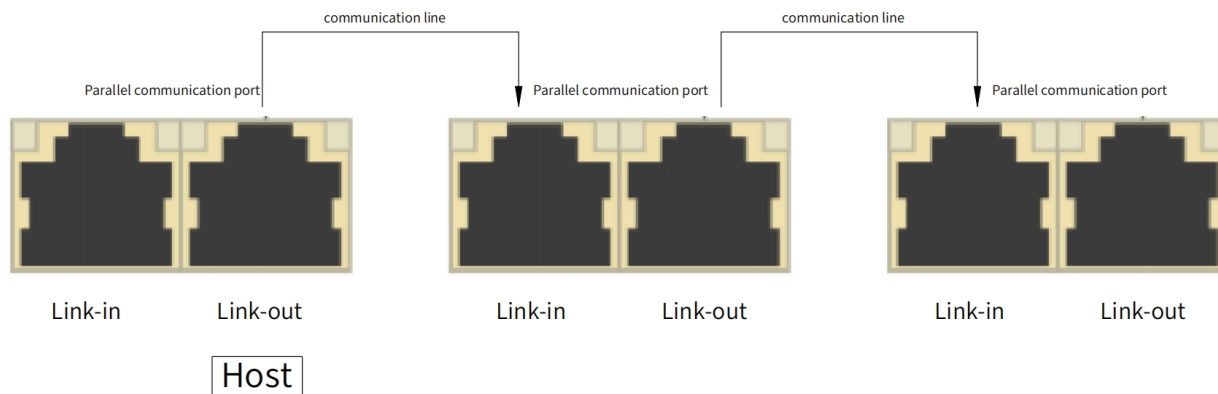

6.5. Interface Definition

Parallel Input Port-8P8C Vertical RJ45				Parallel Output Port-8P8C Vertical RJ45			
RJ45 Pin	Definition	RJ45Pin	Definition	RJ45 Pin	Definition	RJ45Pin	Definition
1	RS485B	5	CANL	1	RS485B	5	NC
2	RS485A	6	RS485A1	2	RS485A	6	RS232-TX
3	RS485B1	7	UP_IN	3	RS232-RX	7	DN_OP+
4	CANH	8	GND	4	GND	8	GND

Configuration process

Step 1: Confirm the energy storage system is powered on and communicating properly with the inverter (the inverter panel should display battery status without fault alarms).

Step 2: Download the corresponding Solis official app based on your inverter's brand and model.

Step 3: Connect the inverter to the home network or mobile hotspot using either the built-in WiFi/4G module or an external data collector.

Step 4: Add the device in the APP, scan or manually enter the inverter serial number to complete binding.

Monitoring and Operation

After logging in to the APP, you can view the "Energy Storage" or "Battery" page:

- 1) Multi-system data: total voltage, total current, SOC (remaining battery capacity), SOH (state of health), and total power.
- 2) System/package-level information (e.g., support): View voltage, status, and alarm information for each parallel system.
- 3) Operation settings: operating modes (e.g., self-generation and self-consumption, peak shaving and valley filling), charging/discharging time, SOC setpoint, etc.

System Self-Check and Status Verification

Perform self-check on all LED lights (red, blue, green) using the running light mode. After powering on, display the self-check results for all LEDs as shown below:

- 1) The red water flow indicator light displays a gradual increase in red color from the power indicator LED-01, eventually turning fully on and then off, before entering the next cycle.
- 2) The blue water flow indicator light and yellow display gradually increase from the power indicator LED-01, eventually turning fully on and then off, before entering the next cycle.
- 3) The green water flow light displays a gradual increase in green illumination starting from the power indicator LED-01 until it reaches full brightness, then switches to operational mode.

After completing the self-check, the corresponding LED status indicators are as follows:

- 1) The panel consists of 4 blue power indicator lights, 1 running light, and 1 alarm light.

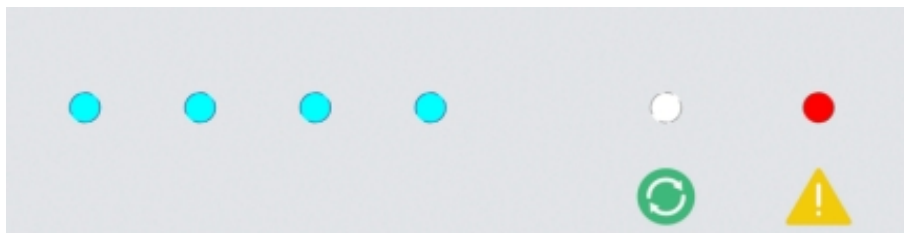

Schematic diagram of light panel

state	Normal/Alarm/Protection	Battery level indicator LED				RUN	ALM	explain
		L1	L2	L3	L4			
		●	●	●	●			
shut down	dormancy	off	off	off	off	off	off	All off
await the opportune moment	normal	Based on power indication				Flash 1	off	Stand by
	report an emergency	Based on power indication				Flash 1	Flash 3	Modular low voltage
charge	normal	Based on power indication				Always on	off	Maximum power LED flashes (flash 2), overcharge alarm ALM does not flash
	report an emergency	Maximum power LED flash 2				Always on	Flash 3	
	Overcharge protection	Always on	Always on	Always on	Always on	Always on	off	If there is no mains power, the indicator light remains in standby mode.
	Temperature, Overcurrent, and Failure Protection	off	off	off	off	off	Always on	Stop charging
discharge	normal	Based on power indication				Flash 3	off	
	report an emergency	Maximum power LED flash 2				Flash 3	Flash 3	
	undervoltage protection	off	off	off	off	off	off	Stop discharging
	Temperature, Overcurrent, Short Circuit, Reverse Connection, and Failure Protection	off	off	off	off	off	Always on	Stop discharging
lose efficacy		off	off	off	off	off	Always on	Stop charging and discharging

LED operating status indicator

state		charge				discharge			
Capacity indicator light		L1●	L2●	L3●	L4●	L1●	L2●	L3●	L4●
quantity of electricity (%)	0 ~ 25%	Flash 2	off	off	off	Always on	off	off	off
	25 ~ 50%	Always on	Flash 2	off	off	Always on	Always on	off	off
	50 ~ 75%	Always on	Always on	Flash 2	off	Always on	Always on	Always on	off
	75 ~ 100%	Always on	Always on	Always on	Flash 2	Always on	Always on	Always on	Always on
Run indicator light ●		Always on				Flash (Flash 3)			

LED capacity indicator

Flash mode	On	Off
Flash 1	0.25s	3.75s
Flash 2	0.5s	0.5s
Flash 3	0.5s	1.5s

LED flashing indicates

6.5. BMS Firmware Upgrade

To ensure optimal performance and reliability, the Battery Management System (BMS) firmware can be upgraded either remotely or locally. Please follow the instructions below.

1) Remote Upgrade

The BMS firmware can be upgraded remotely via the Solis Cloud platform.

When a firmware upgrade is required, please contact an authorized Solis Energy Storage support specialist. The upgrade will be initiated remotely after necessary verification. No on-site operation is required from the user. Ensure that the system remains powered and connected to the internet during the remote upgrade process.

2) Local Upgrade

For a local firmware upgrade, please contact an authorized Solis Energy Storage support specialist to obtain the latest firmware package and detailed upgrade instructions.

The upgrade must be performed by qualified personnel following the provided guide. Ensure the system is safely powered down (if required) and all safety precautions are observed before proceeding. Do not attempt a local upgrade without proper guidance, as incorrect operation may lead to system malfunction.

Note:

- 1) Always confirm the firmware version before and after the upgrade.
- 2) Do not power off the system during the upgrade process unless explicitly stated in the instructions.
- 3) For any questions, contact Solis Energy Storage technical support.

6.6. SolisCloud Quick Commission Guide

Introduction

Quick Commission is a brand-new SolisCloud feature. It provides clear, step-by-step guidance to walk you through the entire setup—from logger networking and device configuration to plant creation—in just minutes, allowing you to quickly and smoothly begin your PV system monitoring journey.

Procedure

To download the app, scan the QR code or search for "SolisCloud" in your app store. Log in to SolisCloud with your username and password. If you don't have an account, click 'Sign up' and follow the prompts to create one.



Note: The version needs to be higher than V5.2.221 and ME-Try the new version is opened

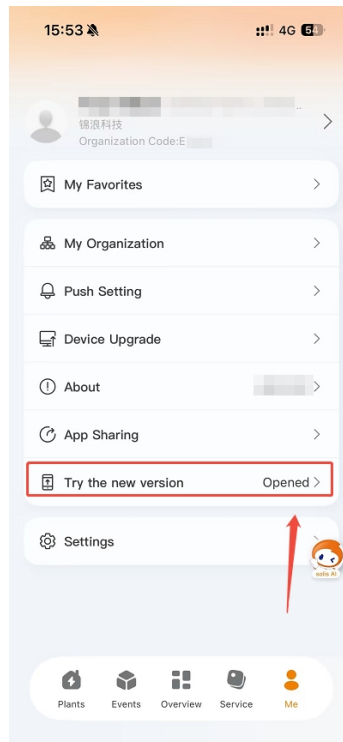

Accessing the Feature: Go to [Service] -> [Common Tools] -> [Quick Commission].

Scan the logger's QR code or select the logger from the Bluetooth list to enter the Quick Commission page.

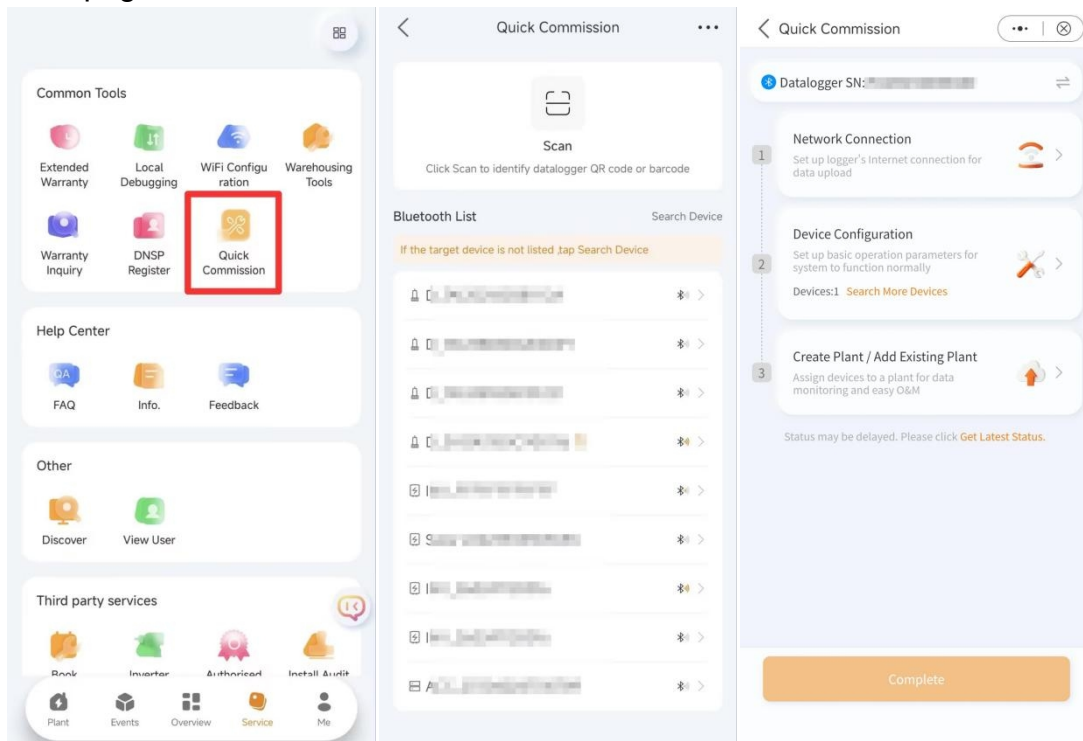

Step1-Network Connection

Click [Network Connection]. The system will automatically identify the logger type and mode. Please make the corresponding settings according to the prompts. After configuration, click [Connect] to complete the connection. The Network Connection step will be highlighted.

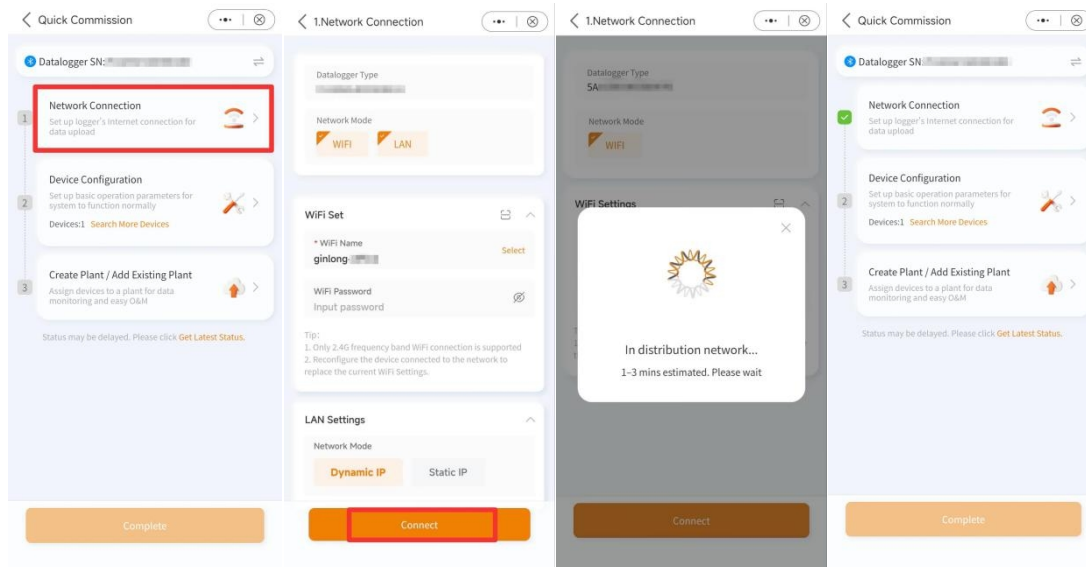

Note: When setting up WiFi, you can scan a WiFi QR code shared by others, or click [select] to choose a WiFi network(on Android, this opens a drop-down list; on iOS, it redirects to system settings).

Step2 - Device Configuration

Click [DeviceConfiguration]. All inverter devices connected to the current logger will be displayed.

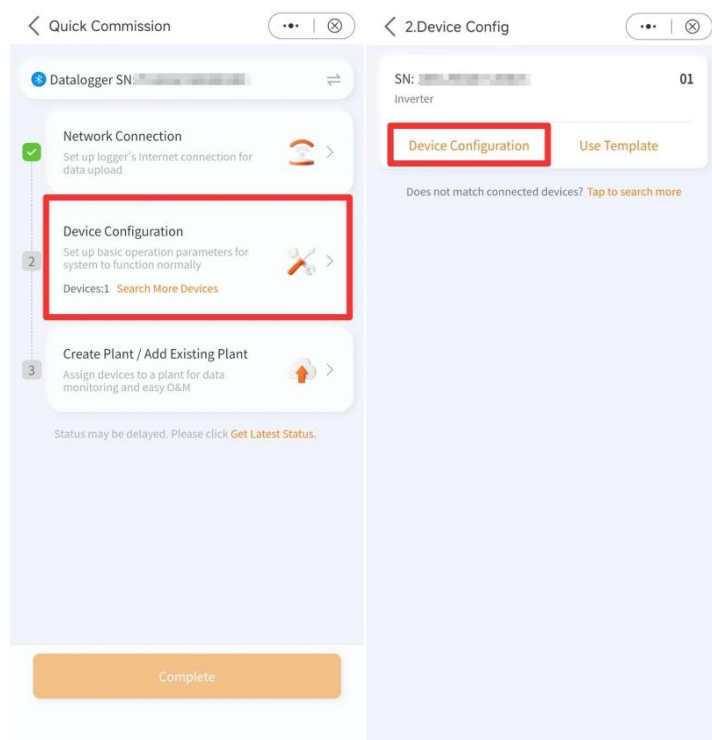

Proceed in order: Set Parameters -> Set Energy Storage Mode -> Diagnosis.

Note:Configurable parameters vary by device model. Please follow the options available on your specific interface.

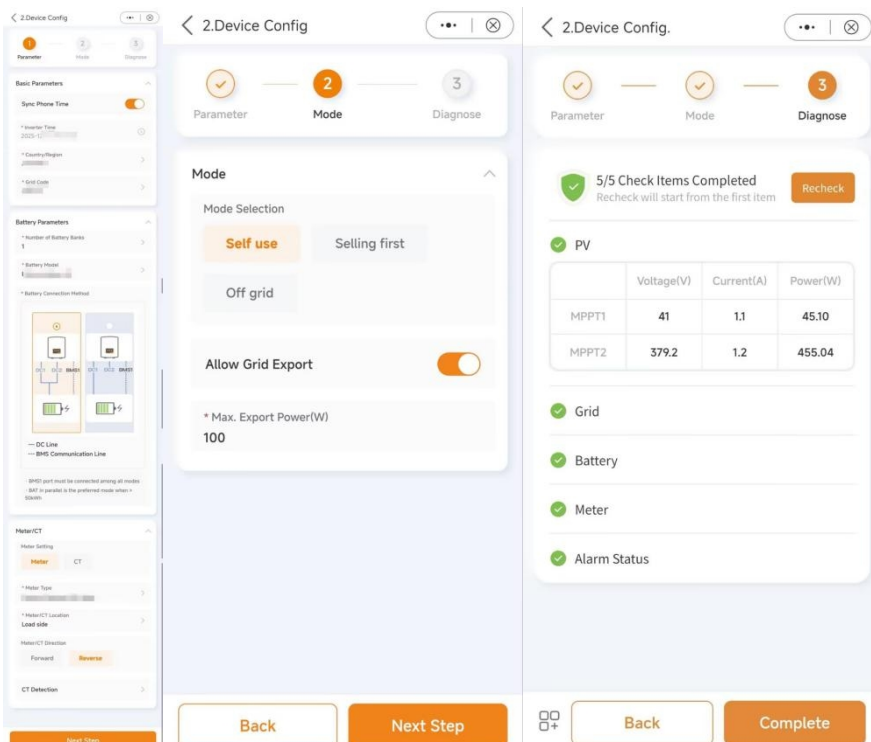

Diagnosis includes 5 diagnostic items: PV, Grid, Battery, Meter, Alarm Status. If an issue is found in any item, you can click to view detailed information and suggested solutions.

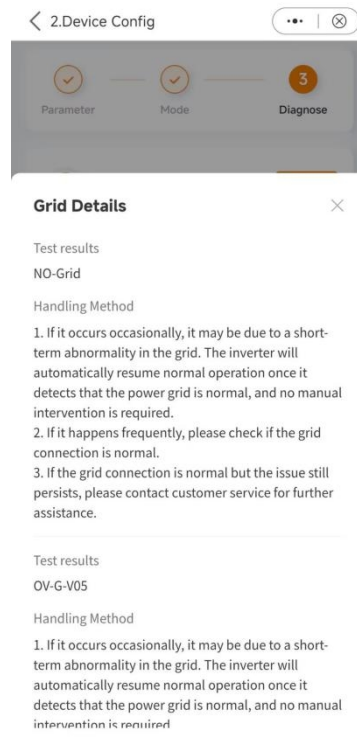

After configuration is complete, the device will be marked as [CONFIGURED], and the Device Configuration step will be highlighted. You can click [CONFIGURED] to jump directly to the local device details page.

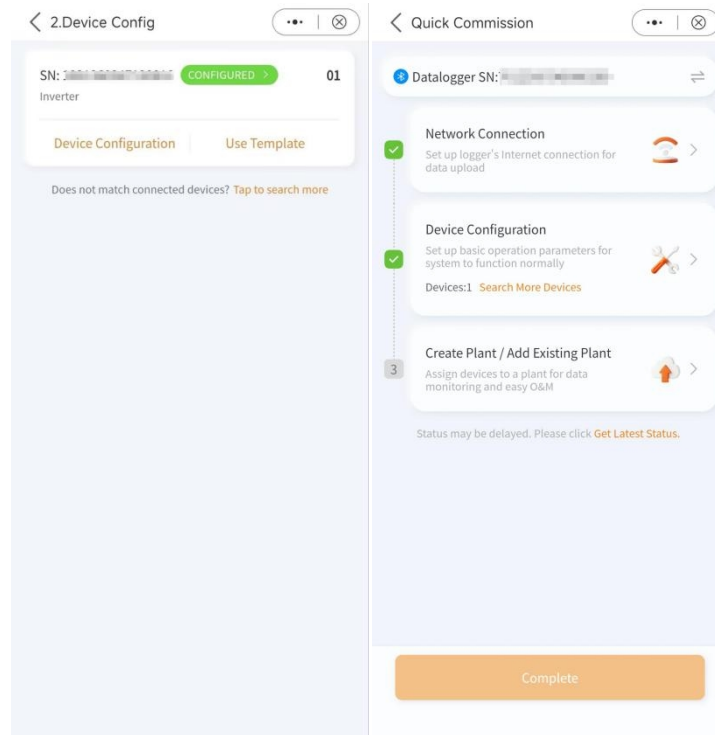

Step3 - Create Plant/Add Existing Plant
Create Plant

If you want to bind the devices to a new plant, click [Create Plant]. Follow the instructions to fill in the relevant information and complete the plant creation.

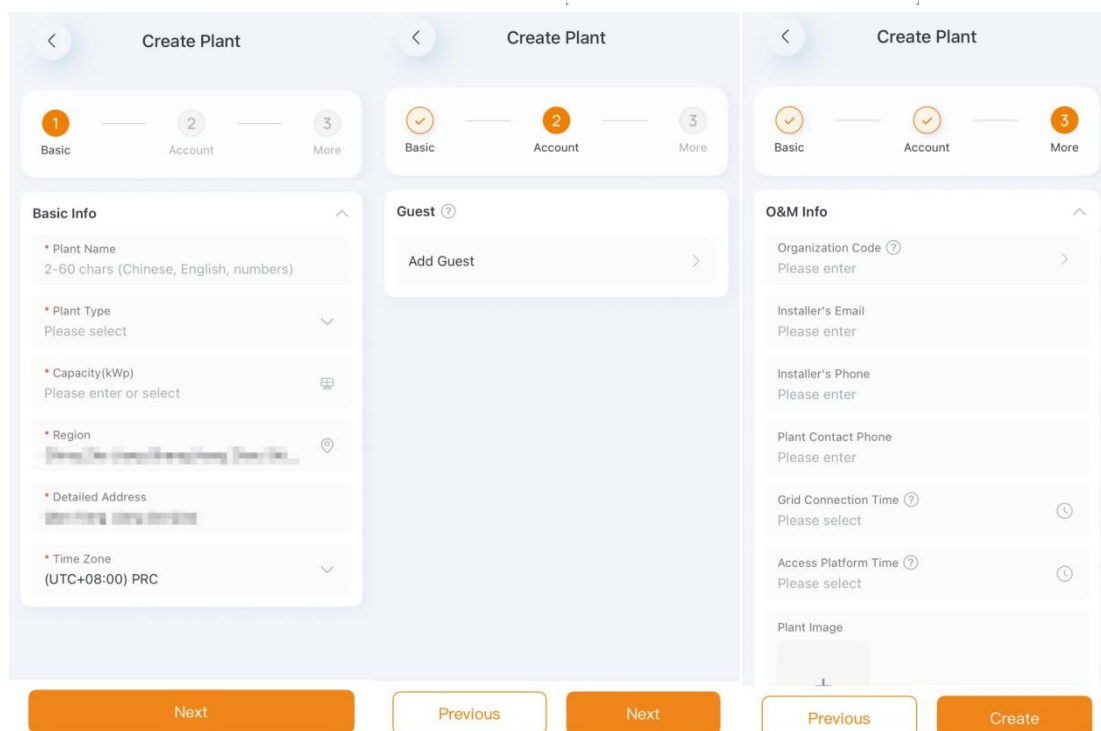
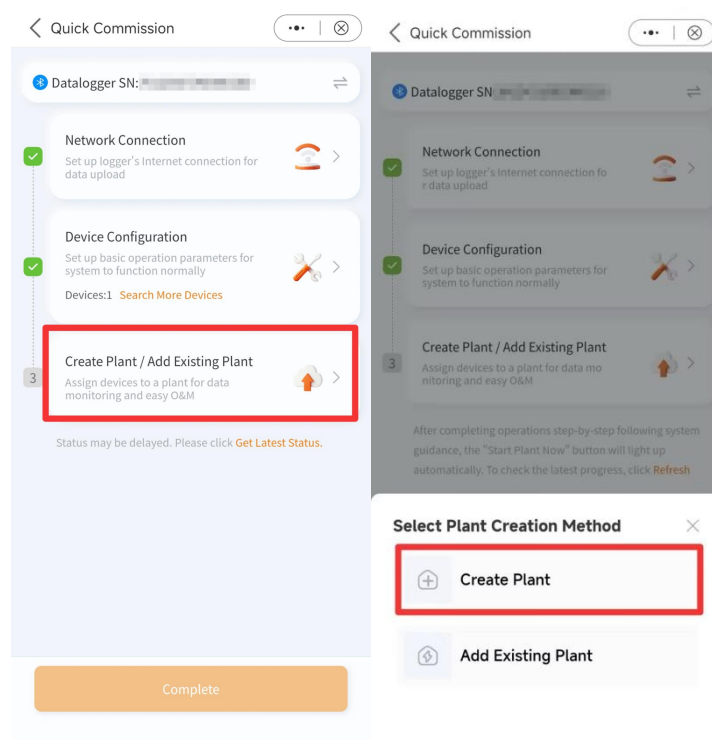

Add Existing Plant

If you want to bind the devices to an existing plant, click [Add Existing Plant]. You can search and view all plants under your account. Select a plant and click [OK].

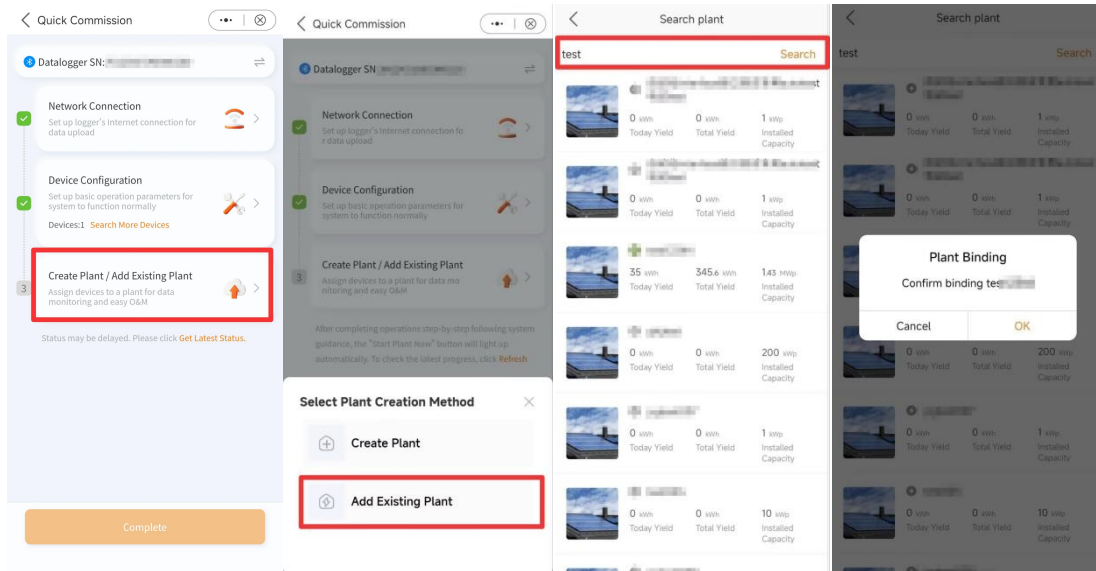

After completing the above steps, the Create Plant/Add Existing Plant step will be highlighted. Click [Complete] to enter the plant page and complete the commissioning.

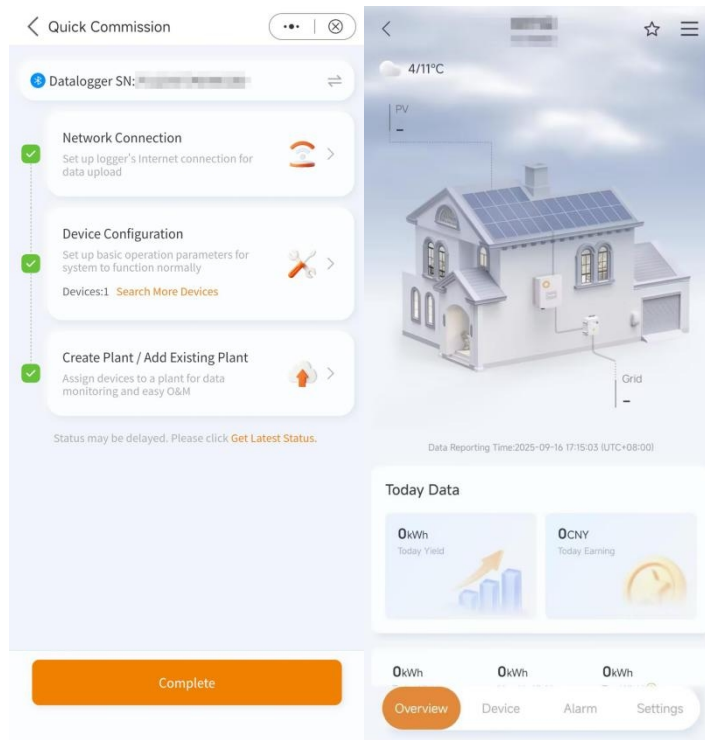

7. System Maintenance

Danger:

- 1) Use dedicated protective equipment and specialized insulating tools to prevent electric shock injuries or short-circuit faults.
- 2) Smoking or open flames are prohibited near batteries.
- 3) The use of wet cloths to clean exposed copper busbars or other potentially conductive parts is prohibited.
- 4) Do not clean batteries with water or any solvent.

Warning:

- 1) Live battery maintenance is prohibited. Operations such as screw torque verification and tightening require battery de-energization. These procedures may only be performed after thoroughly explaining potential risks to the client, obtaining written consent, and implementing effective preventive measures.
- 2) After battery discharge, it should be charged promptly to prevent damage caused by over-discharge.
- 3) When relocation or rewiring is required, the power supply must be disconnected. Wait for 5 minutes until the internal energy of the machine has been fully discharged. After confirming with a multimeter that there is no hazardous voltage on the DC busbar and the internal components requiring maintenance, maintenance can proceed.

Caution:

- 4) It is prohibited to connect two or more cables in parallel at the power interface of battery positive and negative terminals.
- 5) During cable production, maintain a safe distance from equipment to prevent accidental entry of cable debris into machinery, which may cause sparks leading to personal injury or equipment damage.

7.1. Energy Storage System Startup/Shutdown Procedure

Warning:

- 1) After power-off, residual electricity and heat may remain in the chassis, posing risks of electric shock or burns. Therefore, wait at least 5 minutes after system de-connection before performing any operations on the energy storage unit while wearing protective gloves. Maintenance procedures must only be conducted after all indicator lights of the energy storage system have been extinguished.
- 2) During energy storage system operation, simply disconnecting the circuit breaker switch for energy storage cannot completely de-energize the system, making maintenance operations on the storage system inadvisable at this stage.

Energy Storage System Power On/Off Procedure

Power-On Procedure:

Please refer to section 6.2 and 6.3.

Power-Off Procedure:

Step 1: Press the power button for over 3 seconds until the indicator light flashes, then release the button until the light turns off.

Step 2: For a complete power shutdown, open the circuit breaker cover and manually switch the circuit breaker to the "OFF" position.

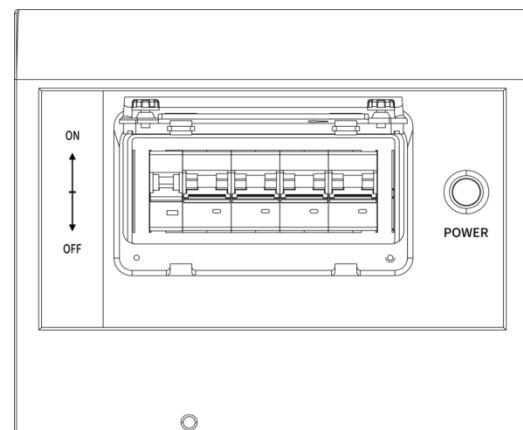
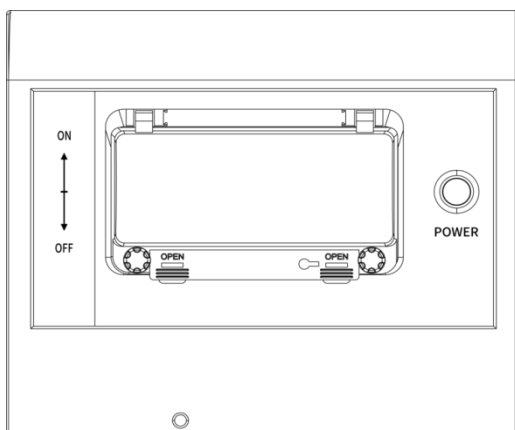

7.2. Decommission of Battery Replacement

When a battery needs to be replaced due to a fault or end of service life, no additional unbinding or decommission operation is required.

To replace the battery, follow the steps below:

- 1) Safely disconnect the battery
Power off the system and follow proper safety procedures. Disconnect the cables between the battery and the inverter in a safe and compliant manner.
- 2) Remove the old battery and install the new one
Remove the faulty or depleted battery, then install the new battery and reconnect the cables properly.
- 3) Automatic recognition by the inverter
Once the new battery is connected, the inverter will automatically detect and recognize the new battery. No manual configuration or binding operation is needed.
- 4) Local data of the old battery does not interfere
Any local data or settings stored from the old battery will not affect the identification or operation of the newly connected battery.

Information of Replaced Battery on the Solis Cloud:

- 1) The old battery may leave a device record on the Solis Cloud platform. After disconnection, it will appear as an "Offline Device" in the cloud interface.
- 2) This offline status does not affect the normal operation of the new battery or the rest of the system.
- 3) Users can manually delete the offline device record of the old battery from the Solis Cloud platform at any time.

Note:

- 1) Always conduct battery replacement in accordance with local electrical safety regulations and the installation instructions provided by Solis Energy Storage.
- 2) If you are unsure about any step, contact Solis Energy Storage official support for assistance.
- 3) Please ensure that any replaced old battery is disposed of in full compliance with all applicable local laws and regulations.

7.3. Regular Maintenance Items

Maintenance Considerations

- 1) When the system is not used for an extended period, disconnect the charging power supply.
- 2) When stored for a long time, perform a charge and discharge cycle every six months.
- 3) The installation and repair of battery systems shall be performed by trained professionals.
- 4) During handling, handle with care to avoid severe impacts on the battery.

Table 7-2 Maintenance List

Scope of Examination	Testing Method	Maintenance Cycle
System Status	<ul style="list-style-type: none"> ➤ Observe whether the exterior of the energy storage unit shows any damage or deformation. ➤ Monitor for any abnormal sounds during energy storage operation. ➤ During energy storage operation, verify that all parameters are correctly configured. 	Once every six months.
Electrical Connection	<ul style="list-style-type: none"> ➤ Check whether cable connections are loose or detached. ➤ Inspect the cable for any damage, with particular attention to checking for signs of cuts on the sheath that contacts the metal surface. ➤ Check unused DC input terminals, energy storage terminals, COM interface, and waterproof cover to ensure they are securely locked. 	The initial debugging should be conducted every six months, followed by subsequent adjustments every six months to one year thereafter.
Grounding Reliability	Check whether the grounding cable is properly grounded.	The initial debugging should be conducted every six months, followed by subsequent adjustments every six months to one year thereafter.

7.4. List of Common Faults and Solutions

order number	hitch	Phenomenon Description	Fault Analysis and Troubleshooting
1	The system cannot start.	No indicator light illuminates when the start switch is activated.	Check whether the input circuit breaker is closed; verify if the self-locking switch is fully engaged; inspect the low-voltage communication cable in the compartment for looseness.
2	Inter-system communication error	The app displays only some systems or shows offline systems.	Check whether the 485 wiring sequence between systems (A-A, B-B) is correct; verify if the communication lines are properly connected; restart the main system.
3	Inverter CAN communication interruption	The inverter displays 'Battery not connected' or 'Communication failed'.	Check if the CAN cable is connected in reverse (CAN-H, CAN-L); restart the inverter and energy storage system; inspect the quality and length of the CAN cable.
4	System alarms (e.g., overvoltage, undervoltage, overheating)	The system indicator light activates an alarm, and the app displays a notification alert.	View the specific alarm code directly through the APP; check the ambient temperature; contact after-sales service and do not handle it yourself.
5	Multisystem SOC imbalance	After prolonged operation, significant differences in System-on-Chip (SOC) configurations were observed across various systems.	Ensure all system models and batches are identical; perform one complete full charge-full discharge balancing cycle; if unevenness persists, contact after-sales service.
6	Abnormal system charge-discharge power	Intermittent charging and discharging, abnormal voltage and current, etc.	Check the current charge/discharge settings of the energy storage inverter. Verify that all system statuses displayed on the APP/cloud platform are normal with no alarms. Inspect the CAN communication lines. Contact after-sales service for detailed charge/discharge data.

7	Sudden battery life decline	Power consumption is too high, and the SOC display is abnormal	Voltage consistency of individual battery cells (presence of lagging cells); whether equipment standby power consumption is excessively high (static current leakage); contact after-sales service;
8	Charging/Discharging failed	Cannot charge from mains power or solar PV, and the battery cannot discharge externally. The BMS indicates a charge/discharge fault.	Check whether the charging/discharging voltage/current matches the equipment's rated values; verify if the charging/discharging contactors are engaged and if the charging/discharging circuit fuses are open; inspect the BMS charging/discharging protection trigger conditions (overvoltage/undervoltage/overcurrent/high temperature/low temperature); contact after-sales service.

7.5. Main component replacement steps

- 1) Power off the equipment according to Section 7.1. Shutdown Procedure.
- 2) Use a multimeter to measure the voltage of the equipment and ensure it is completely powered off.
- 3) Remove the lid;
- 4) Remove the B+ and B-power lines along with their corresponding harnesses on the board.
- 5) Remove the input and output copper busbars from the BMS board.
- 6) Remove the screws from the BMS board;
- 7) Refer to Section 4.5 Equipment Installation Procedure, reverse-engineer the device disassembly process to replace faulty battery modules/controllers.
- 8) Assemble the equipment according to the 4.5 Equipment Installation Procedure
- 9) Installation Step 4) Reinstall the disassembled wiring lines in their original positions one by one.
- 10) Follow the startup procedure outlined in Section 7.1 to power on the equipment normally.

7.6. Maintenance Requirements

Maintenance procedures must strictly adhere to the equipment operation manuals, protection setting documents, and other specifications provided by our company, with strict prohibition of non-compliant operations. Regular inspections and maintenance shall be conducted during equipment operation to ensure normal functionality. Should any safety hazards or malfunctions be detected, immediate contact with our after-sales service team is required. Our technical experts will promptly assist in troubleshooting and repairs to restore equipment functionality. Unauthorized operations or failure to follow instructions are strictly prohibited. Any resulting casualties, equipment malfunctions, or operational losses caused by improper handling shall not be the responsibility of our company, and we shall not assume liability for such incidents.

During operations and maintenance, any tasks involving the following procedures must be performed under the guidance of our company's professional technical personnel.

- 1) Package unpacking operation;
- 2) Battery pack, Control box, and PCS internal inspection and replacement of accessories/components operations;
- 3) Replacement of electrical control boxes and electrical components;
- 4) Operation of power harnesses and communication harnesses including insertion, removal, and replacement;
- 5) Troubleshooting device failures and system shutdowns;
- 6) Abnormal noises and odors were observed during the operation of the equipment.

All maintenance operations involving the aforementioned procedures must be conducted under the guidance of our company's professional technical personnel. Unauthorized modifications are strictly prohibited.

7.7. Warranty Information and Requirement

- 1) For detailed warranty terms, conditions, and coverage, please refer to the separate *Limited Product Warranty* document provided with your product. That document contains important information regarding warranty duration, eligibility, claim procedures, and any applicable exclusions or limitations. It is your responsibility to read and understand the warranty document before operating or maintaining the product.
- 2) Please be aware that any unauthorized modification, disassembly, repair, or alteration of the product – including but not limited to changes to hardware, firmware, electrical connections, or safety features – will immediately void the product warranty. Only modifications or repairs performed by officially authorized service personnel or in accordance with written instructions from the manufacturer are permitted. Damage resulting from unauthorized changes will not be covered under warranty, and the user may be held liable for any resulting system failures or safety hazards.

8. Emergency Procedures

8.1. Emergency Treatment

The electrolyte is corrosive, and contact may cause skin irritation and chemical burns. In case of exposure to battery electrolyte, take the following measures:

- 1) Inhalation: Evacuate the contaminated area, immediately inhale fresh air, and seek medical assistance immediately.
- 2) Eye contact: Immediately rinse the eyes with large amounts of water for at least 15 minutes, do not rub, and seek medical assistance immediately.
- 3) Skin contact: Wash the affected area immediately with plenty of water and soap, and seek medical help immediately.
- 4) Administration: Seek immediate medical attention.

8.2. On-site Response Plan for Electric Shock Accident

Emergency Response Procedure for Accidents

- 1) Following the occurrence of an electric shock accident, on-site personnel immediately implemented emergency measures by disconnecting all power supply directions in the affected area of the workers and reporting the incident to the operations and maintenance (O&M) supervisor. The O&M supervisor promptly organized on-site first aid and notified the security department and administrative department of the relevant situation. Depending on the circumstances, emergency medical services (120) were promptly contacted for assistance.
- 2) After the electric shock victim is separated from the live conductor, they should be promptly moved to a safe area and immediate first aid for electric shock should be initiated. Emergency treatment can only be administered on-site immediately after confirming that the circuit is de-energized, following the victim's separation from the live wire.
- 3) If the electrocuted person is at a height, there is a risk of falling from the elevated position after disconnection from the power source. Appropriate measures must be taken during the transportation of the injured to prevent secondary injuries.

Emergency response measures for accidents

- 1) If the electrocuted individual has minor injuries, remains conscious but exhibits symptoms such as panic, limb numbness, generalized weakness, or has experienced transient loss of consciousness, the patient should be allowed to rest quietly without movement and closely monitored. Simultaneously, emergency services should be alerted by dialing the ambulance number, and the electrocuted individual should be promptly transported to a hospital.
- 2) If the electrocuted individual sustains severe injuries and loses consciousness but retains cardiac activity and respiration, immediately move them to an open area with adequate ventilation. Loosen clothing and position the victim in a supine position with soft padding beneath the body to maintain a slight head-low angle relative to the shoulders to ensure unobstructed breathing. In cold weather, provide warmth and transport promptly to a medical facility. If respiratory distress, weak breathing, or convulsions are observed, prepare emergency resuscitation protocols ready to be activated immediately upon cessation of cardiac activity or respiration.
- 3) If the electrocuted individual sustains severe injuries with cessation of respiration or cardiac activity, or both, immediate resuscitation should be performed using mouth-to-mouth resuscitation and external cardiac compression, followed by hospital transfer. Resuscitation measures must not be discontinued during transportation to the hospital.

Precautions for Emergency Response in Accidents

- 1) When rescuers are unable to confirm whether the accident area has been de-energized, they should wear protective equipment such as electrician's gloves and electrician's shoes, and must not directly contact the electrocuted individual to prevent secondary electric shock.
- 2) If insulated tools must be used when operating tools, metal tools or tools with high conductivity must not be employed.
- 3) Precautions regarding the adoption of rescue countermeasures or measures:
- 4) Rescuers must not use hands, other metals, or damp tools as rescue instruments. Insulated tools must be employed, and rescuers should operate with one hand to prevent electric shock.
- 5) – Prevent potential falls after the electrocuted individual disconnects from the power source, especially when the electrocuted person is at a height. Fall prevention measures should be considered. Even if the electrocuted person is on flat ground, attention must be paid to the direction of potential falls to ensure fall prevention.
- 6) If the accident occurs at night, temporary lighting should be promptly arranged to facilitate rescue efforts and prevent escalation of the incident.
- 7) When electric shock is detected, the power supply should be promptly disconnected, and blind contact with the affected individual must be avoided. If immediate power disconnection is not possible, the on-duty electrician and emergency management personnel should be notified immediately.

8.3. On-site Response Plan for Fire and Explosion Accidents

Emergency Response Procedure for Accidents

- 1) Upon occurrence of a fire incident, the on-duty personnel in the fire control room shall promptly report the fire situation to the supervising personnel, instruct the administrative department staff to disconnect and power off the equipment's main switches, notify the equipment manager of the System Integration and Operations Department to verify the status of the energy storage power station equipment, and immediately proceed to the site to inspect and confirm the condition of the energy storage power station's main equipment.
- 2) Upon receiving a fire incident report, the equipment supervisor of the System Integration and Operations Department shall promptly inspect the specific conditions of the affected equipment through the monitoring backend system, verify whether the fire protection equipment has activated automatically, and provide timely feedback to on-site personnel. They shall also guide and coordinate with personnel for on-site emergency response operations.
- 3) Upon receiving a fire report, the head of the Security Department shall immediately organize initial fire response measures, coordinate rescue forces for firefighting operations, and seek external support from rescue agencies based on actual circumstances.
- 4) When the severity of an accident exceeds the response capacity, on-site personnel should promptly organize evacuation to prevent casualties caused by the fire.

Emergency Response Measures for Accidents

- 1) Emergency Response Measures for Electrical Equipment Short Circuit Fire Accidents
 - After a fire occurs, the power supply should be immediately cut off. Avoid using water or foam fire extinguishers to extinguish the fire at once to prevent electric shock accidents.
 - If power is to be cut off by cutting wires, insulated shoes and gloves should be worn, and insulated tools such as insulated pliers should be used to cut the wires. Different-phase wires should be cut at separate locations to avoid short circuits. When cutting suspended wires, the cutting position should be selected on the support structure facing the power source to prevent the wires from falling to the ground after cutting, which could cause short circuits or electric shock accidents.
 - When the power cable cannot be promptly disconnected, use the dry powder fire extinguisher configured on-site for firefighting. Firefighters must prioritize personal safety and maintain sufficient distance from live electrical components. During electrical fire suppression, high-insulation dry powder fire extinguishers must be employed, and the use of conductive fire extinguishing agents is strictly prohibited.
- 2) Emergency Response Measures for Fires Caused by Material Storage
 - Assess the likelihood of timely fire suppression based on the extent of the flames. If uncertain, immediately report to the head of security and request external support from 119 emergency services. In cases of sufficient personnel availability, promptly dispatch staff to the designated location to guide firefighters while on-site personnel work to contain the fire's outward spread.

If the fire situation can be effectively controlled on-site, firefighting efforts should continue under the premise of ensuring personal safety. In cases of dense smoke, firefighters must immediately wear gas masks. Nearby personnel should promptly gather fire extinguishers from surrounding areas to assist. If the fire proves difficult to contain, immediately connect to the water fire hydrant system. After securing the pipeline, use hydrant water to extinguish the fire. Prior to firefighting, ensure all electrical equipment around the materials has its power supply switches turned off.

After the fire is brought under control, continuous monitoring should be conducted to determine whether complete containment has been achieved, followed by further measures based on actual conditions.

– In cases where the fire cannot be effectively controlled, on-site personnel must act with caution, refrain from entering the fire scene, and await the arrival of firefighters for intervention. Actions to contain the spread of the fire to other areas should only be taken after confirming personal safety.

- 3) Emergency response measures for battery short-circuit fire incidents: The energy storage system employs lithium iron phosphate batteries. Based on current experience, the initial manifestations following a lithium iron phosphate battery short-circuit fire include the generation of substantial smoke and the emission of intense columnar combustion flames.

– Install the energy storage system at the station building, activate the exhaust fan, and open the door of the energy storage area to vent the generated smoke.

– Immediately disconnect the AC power supply switch and the DC switch on the Inverter side;

– After wearing the gas mask, immediately use a fire extinguisher to spray the fire extinguishing medium on the ignition point and maintain a safe distance.

During fire suppression operations, on-site responders must immediately alert surrounding personnel to evacuate the area promptly if an explosion risk is detected in the battery pack, ensuring their own safety.

After the fire is brought under control, continuous monitoring should be conducted to determine whether complete containment has been achieved, followed by further measures based on actual conditions.

– For lithium battery fires, increase water supply at the ignition site to reduce internal battery temperature. Utilize misting or flowering water guns for cooling to lower both surface and internal temperatures of the battery.

– In cases where the fire cannot be effectively controlled, on-site personnel must act with caution, refrain from entering the fire scene, and await the arrival of firefighters for intervention. Actions to contain the spread of the fire to other areas should only be taken after confirming personal safety.

Precautions for Emergency Response in Accidents

- 1) Rescue personnel should adhere to the following precautions when using fire extinguishers: First, release the safety pin. The operator should stand in the upwind position, work sideways, press the handle with hands, and position themselves 2 meters away from the fire source. Direct the hose toward the base of the fire source for sweeping.
- 2) If you catch fire, never panic or attempt to smother yourself with your hands. Such actions create wind currents that accelerate oxygen supply and fuel the flames. The correct procedure is to immediately remove clothing, roll on the ground to smother the flames, and promptly jump into water or have others spray water on the body. Never use foam, dry powder, or carbon dioxide fire extinguishers for firefighting on humans. Instead, use water-based fire extinguishers to spray water directly on the affected area.
- 3) Rescue personnel must wear protective equipment. Individuals without appropriate protective gear are strictly prohibited from participating in rescue operations. During rescue procedures, protective equipment must not be removed due to heat or dryness sensations.
- 4) Rescue equipment must comply with national or industry standards. Proper use of rescue equipment is mandatory, and reckless or improper handling must be avoided. Tools used during rescue operations should undergo centralized decontamination treatment.
- 5) Story handling must strictly follow prescribed procedures, and arbitrary modifications are strictly prohibited.
- 6) On-site personnel and trapped individuals should, following an accident, adopt proactive and effective methods and measures for self-rescue and mutual rescue based on disaster conditions and on-site circumstances, while ensuring their own safety. If rescue conditions are not available at the scene, evacuation should be organized as soon as possible. Rescue measures must be tailored to the actual site conditions and possess corresponding operability

Ginlong Energy Storage Co., Ltd.

No. 57 Jintong Road, Binhai Industrial Park, Xiangshan, Ningbo, Zhejiang, 315712, P.R.China.

Tel: +86 (0)574 6578 1806

Email: info@ginlong.com

Web: www.solisstorage.com

Please adhere to the actual products in case of any discrepancies in this user manual.

If you encounter any problem on the inverter, please find out the inverter S/N and contact us, we will try to respond to your question ASAP.